

M O O N  
by SIMAUDIO

The performance of a lifetime



Owner's Manual  
**MOON 310LP**  
Phono  
Preamplifier

MOON by Simaudio

**simaudio.com**

Simaudio Ltd  
1345 Newton Road, Boucherville, Québec J4B 5H2 CANADA

Date Code: 20182106

<b>IMPORTANT SAFETY INSTRUCTIONS</b>	<b>02</b>
<b>INTRODUCTION</b>	<b>04</b>
<b>DESIGN FEATURES</b>	<b>06</b>
<b>UNPACKING</b>	<b>08</b>
<b>INSTALLATION &amp; PLACEMENT</b>	<b>08</b>
<b>REAR PANEL CONNECTIONS</b>	<b>09</b>
<b>BALANCED OPERATION</b>	<b>09</b>
<b>CIRCUIT BOARD LAYOUT</b>	<b>10</b>
<b>INTERNAL SETTINGS</b>	<b>11</b>
<b>CONNECTING THE UNIT</b>	<b>14</b>
<b>USING THE 310LP WITH AN EXTERNAL POWER SUPPLY</b>	<b>14</b>
<b>SPECIFICATIONS</b>	<b>15</b>

### Important Safety Instructions

1. Read these instructions.
2. Keep these instructions.
3. Heed all warnings.
4. Follow all instructions.
5. Do not use this apparatus near water.
6. Clean only with a dry cloth.
7. Do not block ventilation openings. Install in accordance with the manufacturer's instructions.
8. Do not install near any heat sources such as radiators, heat registers, stoves or another apparatus that produces heat.
9. Do not defeat the safety purpose of the polarized or grounding type plug. A polarized plug has two blades with one wider than the other. A grounding-type plug has two blades and a third grounding prong. The wide blade or the third prong is provided for safety.  
If the provided plug does not fit into the outlet, consult an electrician for replacement of the obsolete outlet.
10. Protect the power cord from being walked on or pinched, particularly at plugs, convenience receptacles, and the point where they exit from the apparatus. Unplug mains cord during transportation.
11. Only use attachments and accessories specified by the manufacturer.
12. Use only with the cart, stand, tripod, bracket, or table specified by the manufacturer or sold with the apparatus. When a cart is used, use  caution when moving the cart/apparatus combination to avoid injury from tip over.
13. Unplug this apparatus during lightning storms or when unused for long periods of time.
14. Refer all servicing to qualified service personnel. Servicing is required when the apparatus has been damaged in any way, such as when the power cord or plug has been damaged; liquid has been spilled or objects have fallen into the apparatus; or the apparatus has been exposed to rain or moisture, does not operate normally, or has been dropped.
15. No naked flame sources, such as candles, should be placed on the apparatus

**WARNING:**  
TO REDUCE THE RISK OF FIRE OR  
ELECTRIC SHOCK, DO NOT EXPOSE THIS  
APPLIANCE TO RAIN OR MOISTURE.

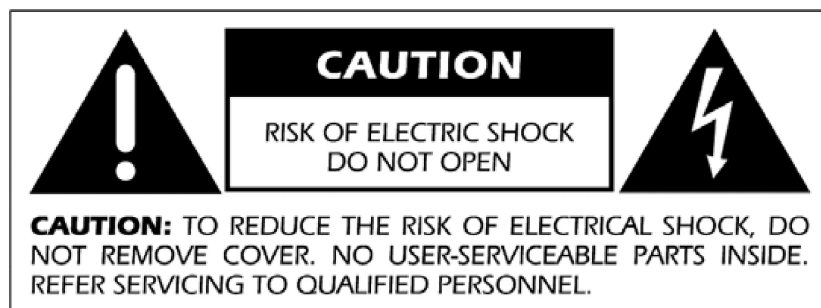



The lightning flash with the arrowhead symbol, within an equilateral triangle, is intended to alert the user to the presence of uninsulated "dangerous voltage" within the product's enclosure that may be of sufficient magnitude to constitute a risk of electric shock to persons.



The exclamation point within an equilateral triangle is intended to alert the user to the presence of important operating and maintenance (servicing) instructions in the literature accompanying the appliance



Marking by the "CE" symbol (shown left) indicates compliance of this device with the EMC (Electromagnetic Compatibility) and LVD (Low Voltage Directive) standards of the European Community

PLEASE READ ALL INSTRUCTIONS AND PRECAUTIONS CAREFULLY  
AND COMPLETELY BEFORE OPERATING YOUR UNIT

1. ALWAYS disconnect your entire system from the AC mains before connecting or disconnecting any cables, or when cleaning any component. To completely disconnect this apparatus from the AC mains, disconnect the power supply cord plug from the AC receptacle.
2. The unit must be terminated with a three-conductor AC mains power cord which includes an earth ground connection. To prevent shock hazard, all three connections must ALWAYS be used. Connect the unit only to an AC source of the proper voltage; Both the shipping box and rear panel serial number label will indicate the correct voltage. Use of any other voltage will likely damage the unit and void the warranty
3. AC extension cords are NOT recommended for use with this product. The mains plug of the power supply cord shall remain readily accessible.
4. NEVER use flammable or combustible chemicals for cleaning audio components.
5. NEVER operate the unit with any covers removed. There are no user-serviceable parts inside. An open unit, especially if it is still connected to an AC source, presents a potentially lethal shock hazard. Refer all questions to authorized service personnel only.
6. NEVER wet the inside of the unit with any liquid. If a liquid substance does enter your unit, immediately disconnect it from the AC mains and take it to your MOON dealer for a complete check-up.
7. NEVER spill or pour liquids directly onto the unit.
8. NEVER block air flow through ventilation slots or heatsinks.
9. NEVER bypass any fuse.
10. NEVER replace any fuse with a value or type other than those specified
11. NEVER attempt to repair the unit. If a problem occurs contact your MOON dealer.
12. NEVER expose the unit to extremely high or low temperatures.
13. NEVER operate the unit in an explosive atmosphere.
14. ALWAYS keep electrical equipment out of reach of children.
15. ALWAYS unplug sensitive electronic equipment during lightning storms.
16. WARNING: Do not expose batteries or battery pack to excessive heat such as sunshine, or fire or the like.

## Introduction

Thank you for selecting the MOON 310LP Phono Preamplifier as a part of your music system. This component has been designed to offer state-of-the-art high-end performance in an elegant package, hallmarks on which Simaudio has made its reputation. We have been building high-performance audio equipment for over 35 years, and the know how gained through our cumulative experience is an important reason why MOON products are so musically satisfying.

The performance of your 310LP will continue to improve during the first 300 hours of listening. This is the result of a “break-in” period required for the numerous high quality electronic parts used throughout this phono preamplifier.

Before setting up your new MOON 310LP, we encourage you to please read this manual thoroughly to properly acquaint yourself with its features. We hope you enjoy listening to the MOON 310LP Phono Preamplifier as much as the pride we have taken in creating this fine audio product. We understand the power and emotion of music and build our products with the goal of faithfully capturing these elusive qualities.

The information contained in this manual is subject to change without notice. The most current version of this manual is available on our official website at

**<http://www.simaudio.com>**

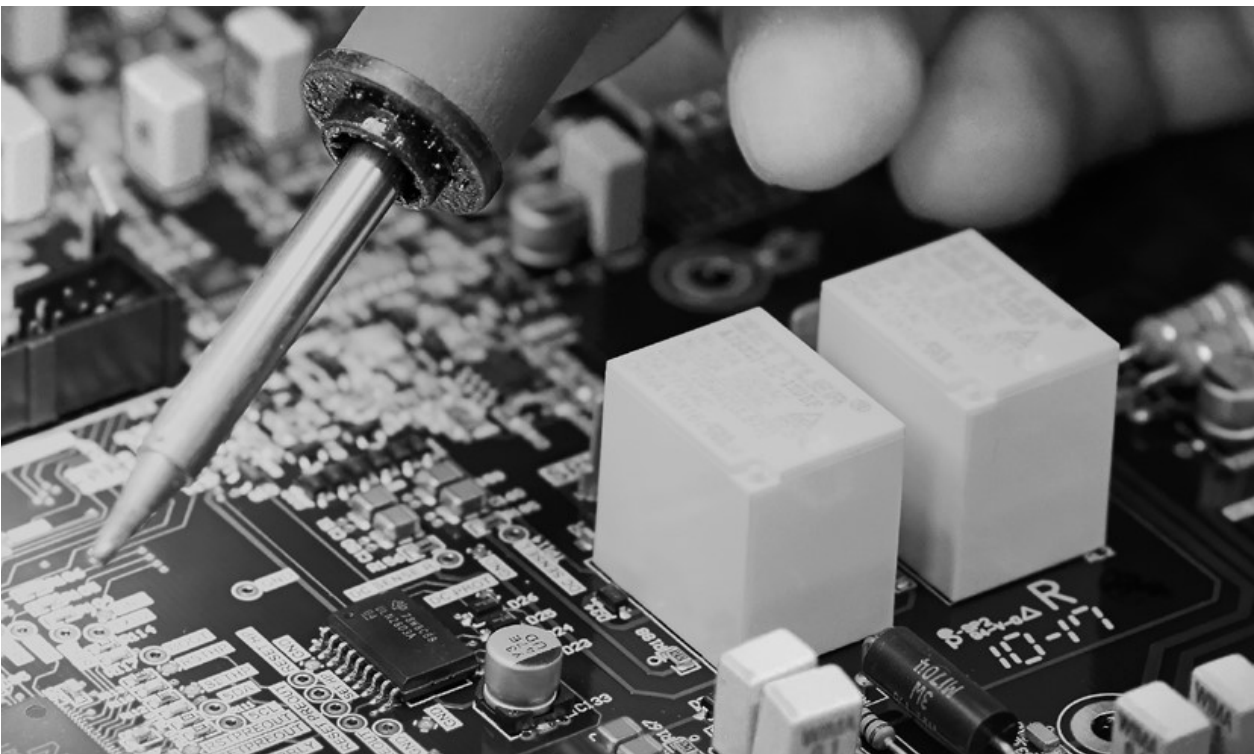
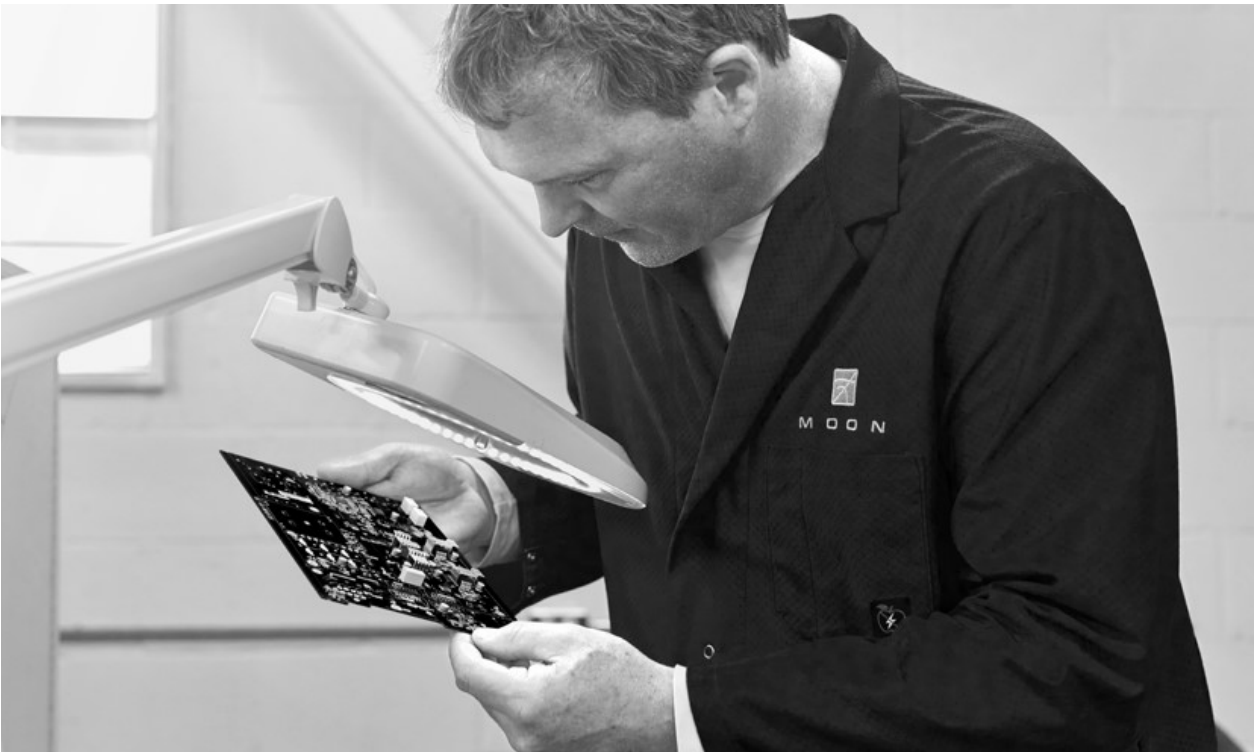

## Design Features

Your MOON 310LP Phono Preamplifier incorporates many significant design features to achieve its “world class” level of performance. This is an abbreviated list of the more important features:

Isolated power supply on a separate circuit board using a toroidal transformer with 2 stages of voltage regulation

An extremely short signal path for a faster transient response

End-user adjustments for capacitance loading, resistance loading and gain level to extract exceptional performance from virtually all high quality phono cartridges

End-user adjustments to alternate between the RIAA and IEC equalization curves

Single-ended RCA and Balanced XLR output connectors

Power supply voltage regulation includes i2DCf (Independent Inductive DC Filtering) derived from the Evolution Series for increased dynamic range

Power supply features custom MOON electrolytic capacitors

Can be driven with an external power supply

Four-layer PCB tracings with dedicated ground and power planes using pure copper for low impedance characteristics. The advantages are better circuit layouts resulting in much shorter signal paths and a vastly improved signal-to-noise ratio

Rigid chassis construction to minimize the effects of external vibrations

A symmetrical circuit design with accurate matching of the very finest high quality electronic components

Designed to be powered up at all times for optimal performance

Low operating temperature for an ultra-long life expectancy.





## Unpacking

The **MOON 310LP** should be removed from its box with care.

The following accessories should be included inside the box with your unit:

- AC Power Cord
- Warranty and product registration information (USA and Canada only)

Once the unit is unpacked, inspect it thoroughly and report any damage to your dealer immediately. We suggest that you keep all of the original packaging, storing it in a safe, dry place in case you're required to transport this product. The customized packaging is specially designed to protect the unit from any potential damage during transit.

*Please write the serial number of your unit in the space provided below for future reference.*

**Serial Number**

## Installation & Placement

The MOON 310LP requires reasonable ventilation to maintain an optimum and consistent operating temperature. As a result, it should be placed in a location with empty space around it for proper heat dissipation. As well, it should be placed on a solid level surface. You should avoid placing it near a heat source or inside a closed cabinet that is not well ventilated as this could compromise this component's performance and reliability. You should never place another component directly on top of this phono preamplifier.

The 310LP is more sensitive than most other types of audio components to EMI (electro-magnetic interference) from power supplies and motors. Consequently, it should be placed at a minimum distance of 18 inches from power supplies, turntables, tape decks, AC line filters, etc.

## Rear Panel Connections

Figure 1: 310LP Backpanel



The rear panel will look similar to Figure 1. There is one pair of single-ended inputs on RCA connectors located in the center with a ground post directly below. Connect the cables from your turntable to these inputs and the ground lead wire to the ground post. The MOON 310LP Phono Preamp has two pairs of outputs; One single-ended pair on RCA connectors and one balanced pair on XLR connectors.

If the preamp or integrated amp you're connecting the 310LP to has balanced inputs, it's highly advantageous to use the 310LP's XLR outputs. This will provide you with an even better signal-to-noise ratio and increased gain by a factor of 6dB. Don't hesitate to use high quality interconnects. Poor quality cables can degrade the overall sonic performance of your system.

Finally on the right side the IEC receptacle, labeled "AC Power" for the included AC power cord. Directly above the IEC receptacle is a 4-pin XLR connector labeled "DC Power"; this is for the optional 310LP external power supply upgrade.

## Balanced Operation

When using an unbalanced interconnect, the audio signal runs through both the center wire and the shield/ground wire. Any noise picked up by this interconnect (ie. nearby magnetic fields such as an AC power cord) will be reproduced by the integrated amplifier, then heard through the loudspeakers. Conversely, a balanced interconnect has three separate conductors; one for the ground and two for the actual signal. These two signals are identical except that one is 180 degrees out of phase with the other.

For example, when one conductor is carrying a signal of +2 Volts, the other will be carrying a signal of -2 Volts. When these two inverted signals on a balanced line are output from the MOON 310LP, any noise picked up by the interconnect will be eliminated since a differential circuit amplifies only the difference between these two signals: Noise on a balanced interconnect will be equal on both conductors and therefore cancel out.

# Circuit Board Layout

Figure 2: MOON 310LP Circuit Board layout for internal adjustments

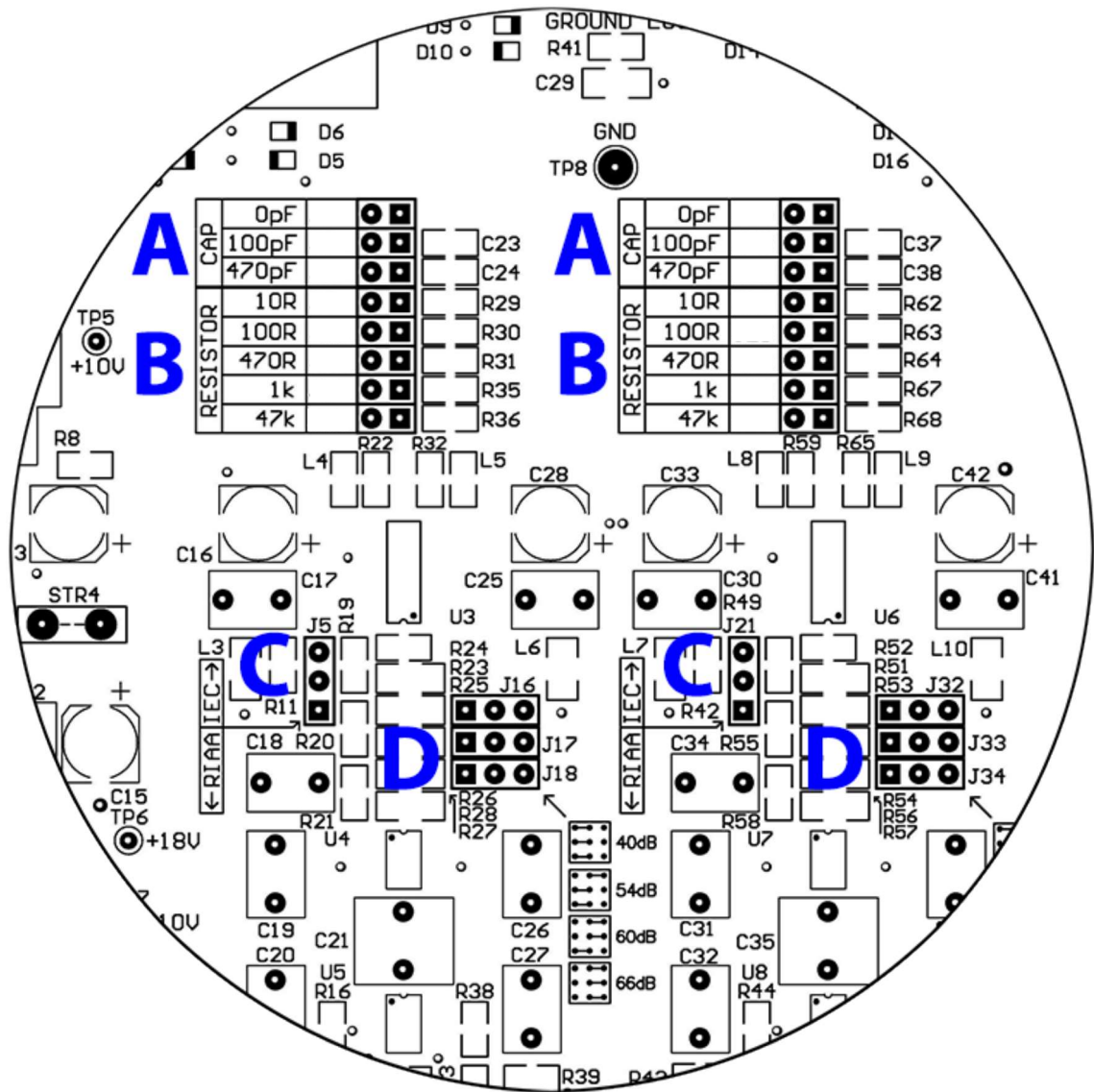

## Available Settings:

- A** – Capacitance loading jumper banks
- B** – Resistance loading jumper banks
- C** – Equalization curve jumper banks
- D** – Gain level jumper banks

## Internal Settings

There are four (4) types of input settings available on the MOON 310LP Phono Preamplifier; Capacitance loading, Resistance loading, Equalization curve and Gain level. Each setting is adjustable through the use of jumpers. For each type of setting, there are 2 banks of jumpers – one each for the left and right channels. This is the result of the 310LP's genuine mirror-image circuit design which yields exceptional stereo separation.

Always place the preamplifier that your 310LP is connected to, either into mute or stand-by mode prior to changing any of the following input settings. Then disconnect the AC power cord from the rear of the 310LP.

There are a total of eight (8) screws that you must remove using a phillips screwdriver - four each on either side of the chassis. Once these screws are removed, carefully lift off the chassis cover. Once the cover is removed, you are ready to make all of the necessary internal adjustments to the 310LP to achieve optimal sonic performance.

### RESISTANCE LOADING

There are five (5) different settings available for setting the resistive load; 10 $\Omega$ , 100 $\Omega$ , 470 $\Omega$ , 1k $\Omega$  and 47k $\Omega$  (refer to figure 3).

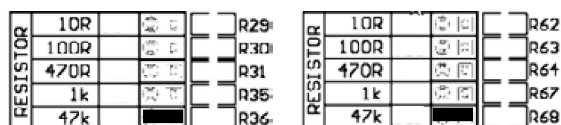

Figure 3: Left and right channel jumper banks default setting for resistance load adjustments

In the event that you're using a moving magnet (MM) cartridge, it is recommended that you leave the jumpers inserted in sockets for a 47k $\Omega$  resistive load. Conversely, if you're using a moving coil (MC) cartridge, experiment with the four (4) other available loads ranging from 10 $\Omega$  through 1K $\Omega$ , selecting the load that provides the best possible sound quality. For example, if you decided on using the resistance setting of 100 $\Omega$ , then you would insert the supplied jumpers into sockets besides 100R (refer to figure 4).

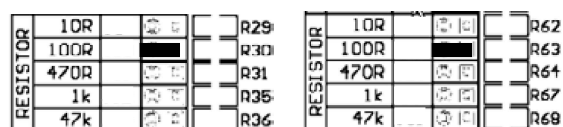

Figure 4: Left and right channels set to a 100 $\Omega$  resistance load

One of the five jumper sockets for each channel must always have a jumper inserted into it, otherwise the 310LP will not produce an output signal. As well, you should always maintain the same resistance setting for both channels, otherwise sound will vary between the left and right channels of your audio system. Finally, it is strongly recommended that you never use the 47k $\Omega$  resistive load setting for moving coil cartridges.

### CAPACITANCE LOADING

There are three (3) different settings available for setting the capacitive load; 0pF, 100pF and 470pF for the left channel and right channel (refer to figure 5).

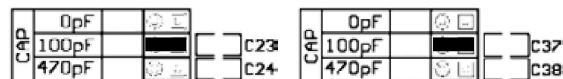

Figure 5: Left and right channel jumper banks default setting for capacitance load adjustments

## MOON by Simaudio

Typically, capacitance loading adjustments will only impact the sonic performance of a MM cartridge. We recommend that when using a MC cartridge, you should set the capacitance load to 0pF by placing the supplied jumpers beside 0pF, respectively for the left and right channels. In the event that you're using a MM cartridge experiment with the three (3) available loads, selecting the load that provides the best possible sound quality. For example, if you decided on using the capacitance setting of 470pF, then you would insert the supplied jumpers into sockets besides 470pF.

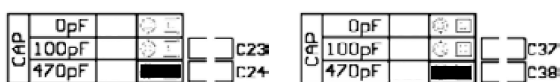

Figure 6: Left and right channels set to a 470pF capacitance load

One of the three jumper sockets for each channel must always have a jumper inserted into it, otherwise the 310LP will not produce an output signal. As well, you should always maintain the same capacitance setting for both channels, otherwise sound quality may vary between the left and right channels of your audio system.

### EQUALIZATION CURVE

The MOON 310LP Phono Preamp is equipped with circuitry for two (2) different equalization curves; The RIAA standard and the less common IEC modified curve. The main difference is that the RIAA curve produces a flat frequency response from 20Hz to 20kHz; The IEC curve acts as a subsonic filter removing inaudible infrasonic bass below 20Hz.

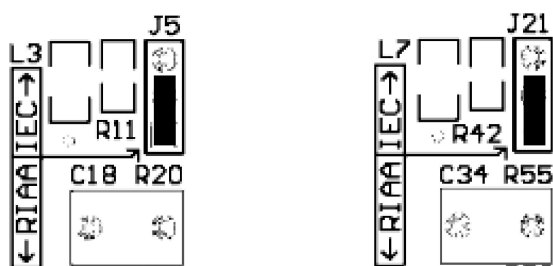

Figure 7: RIAA Equalization curve jumper setting

For the left and right channels respectively, the jumper sockets have three pins allowing for 2 different possible positions. The factory default position is for the RIAA curve as shown in figure 6 where the jumper connects the lower 2 pins. To select the IEC curve, place the jumper over the upper 2 pins as shown in figure 8.

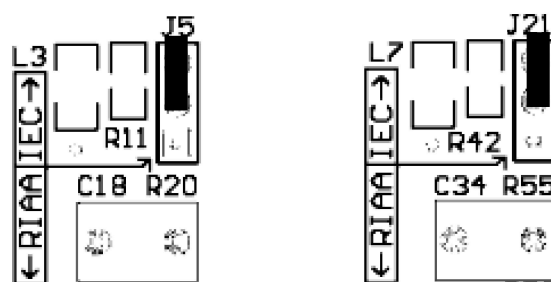

Figure 8: IEC Equalization curve jumper setting

To determine which curve you should use, do as follows: with the 310LP set to the RIAA curve, watch the movement of your loudspeaker's bass drivers – if their motion doesn't follow the pattern of the record currently playing and/or you see excessive driver movement, chances are you should use the IEC curve to eliminate the subsonic information not present on the record.

### GAIN SETTING

There are four (4) gain settings available on the MOON 310LP. They are 40dB for MM cartridges and 54dB, 60dB and 66dB for MC cartridges. However, keep in mind that when using the balanced XLR outputs, each of these gain levels increase by a factor of 6dB to 46dB, 60dB, 66dB and 72dB respectively (note: to keep the circuit board labelling simple, only the single-ended RCA gain levels are indicated).

There are three (3) jumper sockets for each channel that are used to adjust the gain level setting. Each of these jumper sockets have three pins allowing for 2 different possible positions.

As well, there is a detailed diagram printed on the circuit board, located just below and to the right of each of these jumper banks, that shows the jumper positioning for the four available gain settings (see figure 9).

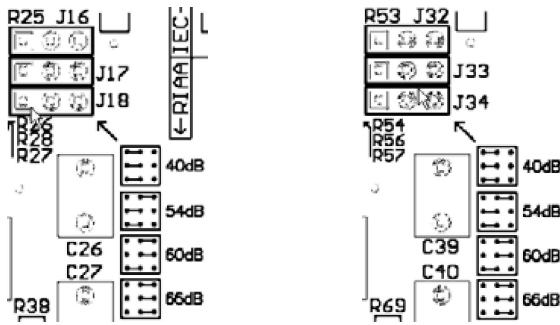

Figure 9: Left and right channel jumper banks for gain level settings

The factory default gain setting is 40dB, whereby all three jumpers in each bank are mounted to the left. In the event that you are using a MC cartridge, you will need to change the gain setting to either 54dB, 60dB or 66dB. The basic rule to determine gain for a MC cartridge is as follows: For a low output MC cartridge (0.7mV and lower), set the gain level to 66dB; for a medium output MC (0.7mV to 1.5mV) set the gain level to 60dB; for a high output MC (> 1.5mV) set the gain level to 54dB. However, as is the case with the other internal settings, let your ears be best judge as to what the best sounding gain setting should be. When using a MM cartridge, never set the gain above 40dB, otherwise you will overload the 310LP's circuit, resulting in a very distorted output signal.

To select a gain level of 60dB, you would mount the jumpers as shown in figure 10.

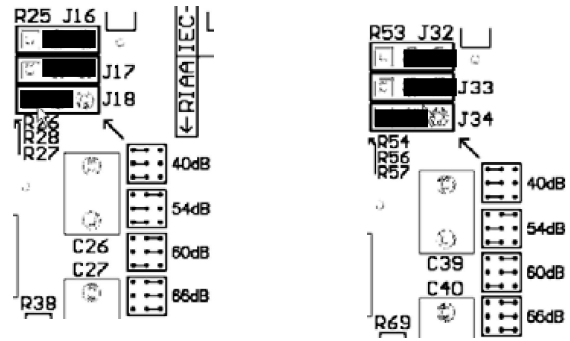

Figure 10: Left & right channels set to 60dB gain

Once you've completed all necessary adjustments, carefully place the chassis cover back into place, making sure that the eight screw holes line up with their respective sockets on the main chassis, and replace the screws.

## Operating the Unit

We recommend that you leave your MOON 310LP Phono Preamplifier powered up at all times to maintain optimal performance. If you plan to be away from your home for a few days, powering off the Phono Preamplifier may not be a bad idea. Once fully “broken-in”, please keep in mind that your 310LP will require several hours of playing time before it reaches its peak performance after you’ve powered it up again.

### TURNING ON YOUR MOON 310LP FOR THE FIRST TIME

Since this Phono Preamplifier is not equipped with an on/off power switch, when connecting/disconnecting the AC power cord you are actually turning the unit on/off. Prior to making the AC connection for the first time, make sure that every cable is properly connected to avoid any problems. Once the 310LP is connected to an AC source, the blue LED on the unit’s front panel will illuminate, indicating that the 310LP is now powered up and ready for use.

### ON AND OFF SEQUENCE

To avoid having any annoying noises (ie. “thumps” and “pops”) emanate from your speakers when powering your 310LP on or off, you should always power up your 310LP phono preamplifier before powering up your preamplifier or integrated amplifier. As well, always power down your 310LP after powering down your preamplifier or integrated amplifier.

## Using the 310LP with an External Power Supply

The MOON 310LP Phono Preamplifier can be operated with the MOON 320S Power Supply (purchased separately). Referring to figure 11 below, you will see an array of four (4) jumper sockets labeled STR1, STR2, STR3 and STR4. The factory default position for the 2 jumpers is in sockets STR2 and STR4 (positions B in figure 11). To properly use the MOON 310LP in conjunction with the MOON 320S, you will need to move these 2 jumpers into sockets STR1 and STR3 (positions A in figure 11). For further details, please refer to your MOON 320S owner’s manual. Failure to make these adjustments may cause damage that is not covered by warranty.

If you are using either the MOON P-8 Controller, MOON 850P Controller as power supply, or the MOON 820S Power Supply, these 2 jumpers must remain in sockets STR2 and STR4 (positions B in figure 11). You should NOT move these jumpers from their factory default position.

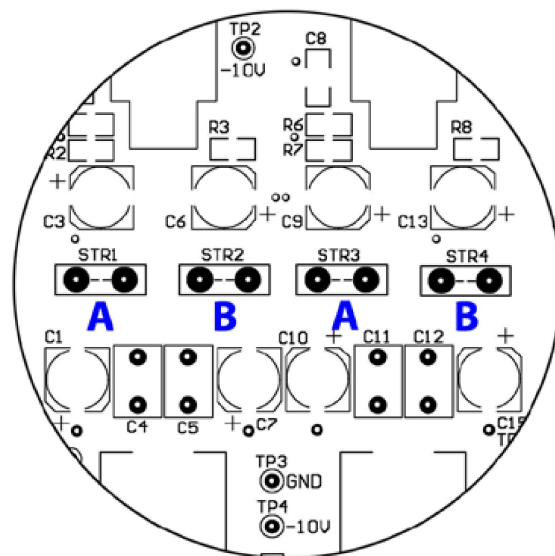

Figure 11: 310LP Circuit Board layout for external power supply



## Specifications

Configuration	Mirror-image symmetrical circuit
Single-ended inputs	1 pair (RCA)
Input Impedance - Adjustable	47, 100, 470, 1k, and 47k $\Omega$
Input Capacitance - Adjustable	0, 100, and 470 pF
Gain – Adjustable (for single-ended outputs)	40, 54, 60 and 66dB
Gain – Adjustable (for balanced outputs)	46, 60, 66 and 72dB
Single-ended outputs	1 pair (RCA)
Balanced outputs	1 pair (XLR)
Input overload @ 40 / 54 / 60 / 66dB gain	58 / 11 / 6 / 3 mV RMS
Signal-to-noise Ratio (full scale @40dB gain)	110dBr
Signal-to-noise Ratio (full scale @66dB gain)	88dBr
Frequency Response – RIAA & IEC Curve	20Hz - 20kHz ( $\pm$ 0.5dB)
IEC Curve Effect	-7dB @ 10Hz
Crosstalk @ 1kHz	100dB
Intermodulation Distortion	0.009%
THD (20Hz - 20kHz)	0.001%
Power Consumption @ idle	6 W
AC Power Requirements	120V / 60Hz or 240V / 50Hz
Shipping Weight	7 lb / 3 kg
Dimensions (W x H x D, inches / cm)	8.0 x 3.25 x 11.0 / 17.8 x 7.6 x 28.0

Balanced Pin Assignment: Pin 1 → Ground Pin 2 → Positive Pin 3 → Negative



Fuse replacement: **120V version use a 0.1A slow blow (5 x 20mm size)**  
**230V version use a 0.1A slow blow (5 x 20mm size)**

Simaudio Ltd.  
1345 Newton Rd.  
Boucherville,  
Quebec, J4B 5H2  
CANADA  
T. 450 449-2212

M O O N  
by SIMAUDIO