MOON 810LP

Reference Dual-Mono Phono Preamplifier



Owner's Manual

M O O N
by SIMAUDIO



Important Safety Instructions

1. Read these instructions.
2. Keep these instructions.
3. Heed all warnings.
4. Follow all instructions.
5. Do not use this apparatus near water.
6. Clean only with a dry cloth.
7. Do not block ventilation openings. Install in accordance with the manufacturer's instructions.
8. Do not install near any heat sources such as radiators, heat registers, stoves or another apparatus that produces heat.
9. Do not defeat the safety purpose of the polarized or grounding type plug. A polarized plug has two blades with one wider than the other. A grounding-type plug has two blades and a third grounding prong. The wide blade or the third prong is provided for safety. If the provided plug does not fit into the outlet, consult an electrician for replacement of the obsolete outlet.
10. Protect the power cord from being walked on or pinched, particularly at plugs, convenience receptacles, and the point where they exit from the apparatus. Unplug mains cord during transportation.
11. Only use attachments and accessories specified by the manufacturer.
12. Use only with the cart, stand, tripod, bracket, or table specified by the manufacturer or sold with the apparatus. When a cart is used, use caution when moving the cart/apparatus combination to avoid injury from tip over.
 
13. Unplug this apparatus during lightning storms or when unused for long periods of time.
14. Refer all servicing to qualified service personnel. Servicing is required when the apparatus has been damaged in any way, such as when the power cord or plug has been damaged; liquid has been spilled or objects have fallen into the apparatus; or the apparatus has been exposed to rain or moisture, does not operate normally, or has been dropped.
15. No naked flame sources, such as candles, should be placed on the apparatus.

WARNING:

TO REDUCE THE RISK OF FIRE OR ELECTRIC SHOCK, DO NOT EXPOSE THIS APPLIANCE TO RAIN OR MOISTURE.



Important Safety Instructions (cont’d)



The lightning flash with the arrowhead symbol, within an equilateral triangle, is intended to alert the user to the presence of uninsulated “dangerous voltage” within the product’s enclosure that may be of sufficient magnitude to constitute a risk of electric shock to persons.



The exclamation point within an equilateral triangle is intended to alert the user to the presence of important operating and maintenance (servicing) instructions in the literature accompanying the appliance.



Marking by the “CE” symbol (shown left) indicates compliance of this device with the EMC (Electromagnetic Compatibility) and LVD (Low Voltage Directive) standards of the European Community

Please read all instructions and precautions carefully and completely before operating your MOON 810LP Phono Preamplifier.

1. **ALWAYS** disconnect your entire system from the AC mains before connecting or disconnecting any cables, or when cleaning any component. To completely disconnect this apparatus from the AC mains, disconnect the power supply cord plug from the AC receptacle.
2. The MOON 810LP must be terminated with a three-conductor AC mains power cord which includes an earth ground connection. To prevent shock hazard, all three connections must **ALWAYS** be used. Connect the MOON 810LP only to an AC source of the proper voltage; Both the shipping box and rear panel serial number label will indicate the correct voltage. Use of any other voltage will likely damage the unit and void the warranty
3. AC extension cords are **NOT** recommended for use with this product. The mains plug of the power supply cord shall remain readily accessible.
4. **NEVER** use flammable or combustible chemicals for cleaning audio components.
5. **NEVER** operate the MOON 810LP with any covers removed. There are no user-serviceable parts inside. An open unit, especially if it is still connected to an AC source, presents a potentially lethal shock hazard. Refer all questions to authorized service personnel only.
6. **NEVER** wet the inside of the MOON 810LP with any liquid. If a liquid substance does enter your MOON 810LP, immediately disconnect it from the AC mains and take it to your MOON dealer for a complete check-up.
7. **NEVER** spill or pour liquids directly onto the MOON 810LP.
8. **NEVER** block air flow through ventilation slots or heatsinks.
9. **NEVER** bypass any fuse.
10. **NEVER** replace any fuse with a value or type other than those specified
11. **NEVER** attempt to repair the MOON 810LP. If a problem occurs contact your MOON dealer.
12. **NEVER** expose the MOON 810LP to extremely high or low temperatures.
13. **NEVER** operate the MOON 810LP in an explosive atmosphere.
14. **ALWAYS** keep electrical equipment out of reach of children.
15. **ALWAYS** unplug sensitive electronic equipment during lightning storms.
16. **WARNING:** Do not expose batteries or battery pack to excessive heat such as sunshine, or fire or the like.

Table of Contents

Introduction	6
Unpacking	7
Installation & Placement	7
Bottom Panel Layout s	8
Cartridge Loading Adjustments	9
Rear Panel Connections	11
Balanced Operation	12
Operating the 810LP	12
Remote Operation	13
Specifications	14

www.simaudio.com

Simaudio Ltd., 1345 Newton Road
Boucherville, Québec J4B 5H2 CANADA

Date Code:20161101

Introduction

Thank you for selecting the **MOON 810LP Dual-Mono Phono Preamplifier** as a part of your music/cinema system. This component has been designed to offer state-of-the-art high-end performance in an elegant package, while retaining all the sonic hallmarks on which Simaudio has made its reputation. We have spared no effort to ensure that it is amongst the finest phono preamplifiers available. We have been building high-performance audio equipment for over 30 years, and the know-how gained through our cumulative experience is an important reason why **MOON** audio components are so musically satisfying.

The performance of your **810LP** will continue to improve during the first 500 hours of listening. This is the result of a "break-in" period required for the numerous high quality electronic parts used throughout this phono preamplifier.

Before setting up your new **MOON 810LP**, we encourage you to please read this manual thoroughly to properly acquaint yourself with its features. We hope you enjoy listening to the **MOON 810LP Phono Preamplifier** as much as the pride we have taken in creating this fine audio product. We understand the power and emotion of music and build our products with the goal of faithfully capturing these elusive qualities.

The information contained in this manual is subject to change without notice. The most current version of this manual is available on our official website at <http://www.simaudio.com>

Your **MOON 810LP Phono Preamplifier** incorporates many significant design features to achieve its "world class" level of performance. This is an abbreviated list of the more important features:

The **oversized power supply**, located within the main chassis, is housed in an **isolated enclosure** that is constructed from **satin coated 14-gauge steel** to eliminate all traces of AC artifacts. Power supply featuring a "**pi-type**" filter using 40,000uF of capacitance and **dual choke inductance** (2x 200mH). The result is a power supply with a noise floor of -150dB related to 1.0V, DC - 100kHz.

4 stages of our newly developed **M-LoVo MOON low voltage DC regulation circuit**; a highly sophisticated circuit made up of a clever combination of IC's and discrete parts that is virtually free of noise, yielding an exceptionally fast, precise, and stable DC voltage. The result is a power supply with a noise floor of -150dB related to 1.0V, DC - 100kHz.

Power supply voltage regulation includes **i²DCf** (Independent Inductive DC Filtering); 1 inductor for each and every chip (i.e. OpAmp, etc.) in the audio circuit's signal path – **24 stages in all**.

The dedicated audio circuit board is mounted on a **5-point gel-based floating suspension**, derived from our **M-Octave** technology, originally developed for the reference **MOON 850P** Preamplifier.

Adjustable impedance loading - 64 available settings from 12.1Ω to 47kΩ

Adjustable capacitance loading - 16 available settings from 0pF to 1120pF

Adjustable gain settings - 16 available settings from 40dB to 70dB

Selectable equalization curves for both the **RIAA** and the **IEC** standards

Customized parts include **metallized polypropylene film capacitors** with very tight tolerances of 1%

Four-layer PCB tracings with dedicated ground and power planes using pure copper for low impedance characteristics. The advantages include better circuit layouts resulting in a much shorter signal path and a vastly improved signal-to-noise ratio

Optional **external** power supply.

Ultra rigid chassis construction to minimize the effects of external vibrations.

The **shortest possible signal path** for a faster transient response and the lowest possible noise floor.

Unpacking

The **MOON 810LP** should be removed from its box with care.

The following accessories should be included inside the box with your phono preamplifier:

- ✓ AC power cable
- ✓ One (1) pen shaped plastic hand tool for making DIP-switch adjustments
- ✓ This owner's manual
- ✓ Warranty and product registration information (USA and Canada only)

Once the **810LP** is unpacked, inspect it thoroughly and report any damage to your dealer immediately. We suggest that you keep all of the original packaging, storing it in a safe, dry place in case you're required to transport this product. The customized packaging is specially designed to protect the **810LP** from any potential damage during transit.

Please write the serial number of your new **MOON 810LP** in the space provided below for future reference.

Serial Number

Installation

The **810LP** is more sensitive than most other types of audio components to EMI (electro-magnetic interference) from power supplies and motors. Consequently, it should be placed at a minimum distance of 18 inches from power supplies, turntables, tape decks, AC line filters, etc. *You should never place another component directly on top of this phono preamplifier.* It should be placed on a solid, level surface. You should avoid placing it near a heat source or inside a closed cabinet that is not well ventilated as this could compromise the preamplifier's performance and reliability.

If the surface you have chosen isn't perfectly level, each of the four (4) cones of your **810LP** are height adjustable; carefully using your fingers, you can either raise each leg by turning the cone underneath clockwise, or lower each leg by turning it counterclockwise.

We strongly recommend that you leave these cones mounted to the component at all times for reasons related to both performance and aesthetics.

Bottom Panel Layout

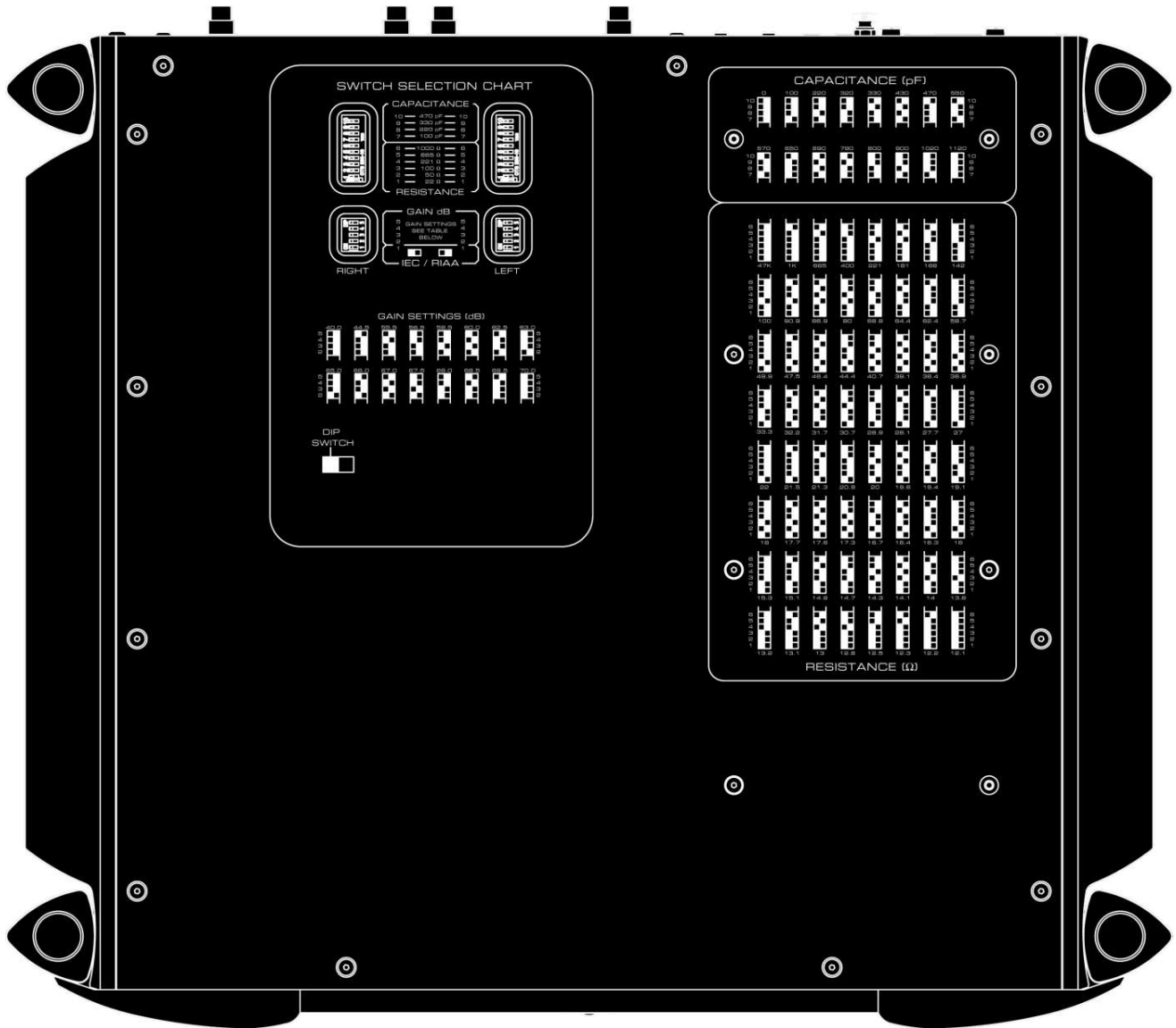

Figure 1: MOON 810LP Bottom Panel layout

Settings for cartridge resistance loading, cartridge capacitance loading, gain and equalization curve are all done using white colored DIP switches located on the **810LP's** bottom panel as shown above in figure 1. There are two (2) banks of DIP switches – The upper bank provides for the capacitance and resistance loading adjustments; the lower bank for gain level and equalization curve settings.

Examples of the DIP switch positions for all available settings are clearly shown on the bottom panel – below and to the right of the actual DIP switches. Since the **MOON 810LP** is a genuine dual-mono design, there are 2 sets of DIP switches for each adjustment – one each for the left and right channels.

Cartridge Loading Adjustments

Prior to making any of these adjustments, always disconnect the AC power cord and all interconnects from **MOON 810LP**. We strongly recommend using the *pen shaped plastic hand tool* that we have included with your **810LP** as it was specifically designed for this purpose. Using another tool made from a material other than plastic may damage the DIP switches and/or scratch the painted surface on the bottom of the **810LP**. Finally, to achieve the best possible sonic performance, it is absolutely necessary that all settings be identical for both the left and the right channels.

In the following examples, **the color white always indicates the position - left ('ON') or right ('OFF') of the DIP switch**. In the example to the left, the DIP switch is in the left position ('ON'). **This is to be consistent with the actual white color of these switches.**

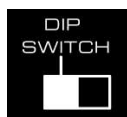

Capacitance Loading:

There are sixteen (16) unique capacitance loading settings available using DIP switches 7 through 10, located at the top of the upper DIP switch bank. The range of available settings begins at 0pF and ends at 1120pF:

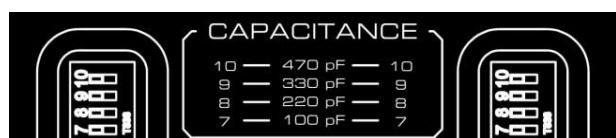

Figure 2: Left and right channel DIP switches for capacitance loading adjustments

The factory default is 100 pF, whereby DIP switches 10, 9, and 8 are all in the right ('OFF') position and DIP switch 7 is in the left position ('ON') as seen in the example to the right. This setting would be applicable for most moving magnet cartridges.



When you are using a moving coil cartridge, you will most likely want to set the capacitance loading to 0pF. This is done by positioning all four DIP switches (7, 8, 9, & 10) to the right position ('OFF') as seen in the example to the right.



A comprehensive diagram of the DIP switch combinations for all 16 available capacitance loading settings can be seen on the bottom panel, immediately to the right of the switches. Finally, the values written beside the DIP switch number represent the capacitance load if only that switch is in the left position ('ON'). For example, when only switch 10 is in the left position ('ON'), the load value will be 470pF; when only switch 9 is in the left position ('ON'), the load value will be 330pF; and finally when only switch 8 is in the left position ('ON'), the load value will be 220pF.

Resistance Loading:

There are sixty-four (64) unique resistance loading settings available using DIP switches 1 through 6, located at the bottom of the upper DIP switch bank. The range of available settings starts at 12.1Ω and ends at 47kΩ:



Figure 3: Left and right channel DIP switches for resistance loading adjustments

The factory default is 47kΩ, whereby DIP switches 6, 5, 4, 3, 2 and 1 are all in the right ('OFF') position as seen in the example to the right. This setting would be applicable for most moving magnet cartridges.



When you are using a moving coil cartridge, you will most likely want to set the resistance loading to a much lower impedance value. For instance, when your cartridge manufacturer recommends a value of 100Ω, you would position DIP switch 3 to the left ('ON') and the other remaining switches (1, 2, 4, 5 & 6) to the right position ('OFF') as seen in the example to the right. *We strongly recommended that you never use the 47kΩ resistive load setting for moving coil cartridges.*



A comprehensive diagram of the DIP switch combinations for all 64 available resistance loading settings can be seen on the bottom panel, immediately to the right of the switches and just below the previously mentioned capacitance settings diagram. Finally, the values written beside the DIP switch number represent the resistance load if only that switch is in the left position ('ON'). For example, when only switch 1 is in the left position ('ON'), the load value will be 22Ω; when only switch 4 is in the left position ('ON'), the load value will be 221Ω; and finally when only switch 6 is in the left position ('ON'), the load value will be 1000Ω.

Note: Choosing a loading impedance for a moving coil cartridge is not an exact science as there are many variables that can affect the manufacturer’s recommended setting. Choosing the best impedance is ultimately a compromise between what sounds best to your own ears and what works best for the cartridge, based on its internal workings. When experimenting with different impedance settings, always keep in mind that a poorly loaded moving coil cartridge will result in sonic performance yielding a lack of definition, reduced bass performance, as well as aggressive upper-mid and high frequencies.

Gain Setting:

There are sixteen (16) unique gain level settings available using DIP switches 2 through 5, located at the top of the lower DIP switch bank. The range of available settings runs from 40dB all the way up to 70.0dB:



Figure 4: Left and right channel DIP switches for gain level settings

The factory default gain level setting is 40dB whereby DIP switches 5, 4, 3 & 2 are set to the right position ('OFF'). This setting would be applicable for most moving magnet cartridges.



The example to the right shows a gain level setting of 60.0dB where DIP switches 5 and 3 are in the left ('ON') position and DIP switches 2 and 4 are in the right ('OFF') position.



When you are using a moving coil cartridge, you will need to increase the gain level setting. This is a general rule for determining the gain of a MC cartridge: For a low output MC cartridge (0.7mV and lower), set the gain level to at least 66dB; for a medium output MC (0.7mV to 1.5mV) set the gain level to 60dB; for a high output MC (> 1.5mV) set the gain level to 54dB. Since every audio system is different, these are just approximated values.

Equalization Curve:

The **MOON 810LP Phono Preamp** is equipped with circuitry for two (2) different equalization curves; The RIAA standard and the less common IEC modified curve. The main difference is that the RIAA curve produces a flat frequency response from 20Hz to 20kHz; The IEC curve acts as a subsonic filter removing inaudible infrasonic bass *only* below 20Hz. Using DIP switch 1 on lower bank. The factory default is the RIAA curve whereby DIP switch 1 is in the right ('OFF') position. To change to the IEC curve, simply move this DIP switch to the left ('ON') position.



Figure 5: Left and right channel DIP switches for equalization curves

To determine which curve is best for you, perform this simple test: Use the **810LP** with the RIAA curve and watch the movement of your loudspeaker’s bass drivers. If their motion doesn’t follow the pattern of the record you’re playing or you see excessive driver movement, chances are you should use the IEC curve to eliminate the subsonic information not present on the record.

Rear Panel Connections

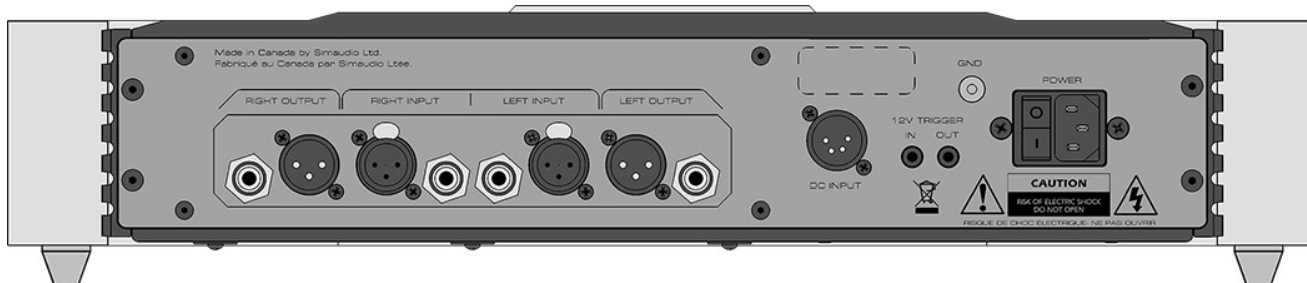

Figure 6: Rear panel of MOON 810LP

The rear panel will look similar to Figure 6 (above). All audio connectors are located on the left side of the rear panel. As a result of the **MOON 810LP Phono Preamplifier's** balanced and symmetrical circuit design, the layout of these audio connectors follows the same orientation: A pair of single-ended RCA input connectors are located in the middle and on either side you will find the balanced XLR input connector for that same channel. Connect the cables from your turntable to either the RCA or XLR inputs. *The design of the 810LP allows for ONLY 1 input connection so you cannot use both types of input connectors.* Immediately to each side of the XLR input connectors are the balanced XLR output connectors. Beside each XLR output is the single-ended RCA output connector for that same channel. You can use either or both the XLR outputs and RCA outputs to connect to your preamplifier/integrated amplifier. If the preamplifier/integrated amplifier you're connecting the **810LP** to has balanced inputs, it's highly advantageous to use the **810LP's** XLR outputs. This will provide you with an even better signal-to-noise ratio.

When you're using the balanced XLR inputs, **you must first remove the factory installed "dummy" XLR jumpers** (see figure 7 below) from the back panel XLR connectors and store them in a safe place. These jumpers are required **ONLY** when using the single-ended RCA inputs. In If you decide to switch to single-ended input mode, you must reinstall the XLR jumper (between pins 1 and 3) exactly as show below. The purpose of these jumpers is to help maintain the lowest possible noise level when not using the **810LP's** balanced input circuitry.

To the right of the array of audio connectors is a 4-pin XLR connector labeled "DC Input" which is reserved for use with the **820S** external power supply. Directly to the right of the 4-pin XLR are two 12 Volt triggers, each on a 1/8" mini-jack; one input and one output, the latter for use in if you wish you to "daisy chain" an additional component on the same trigger circuit. Finally on the far right side is the "AC Power" section with a main power switch ("0"=off, "1"=on) and IEC receptacle for the included AC power cord.

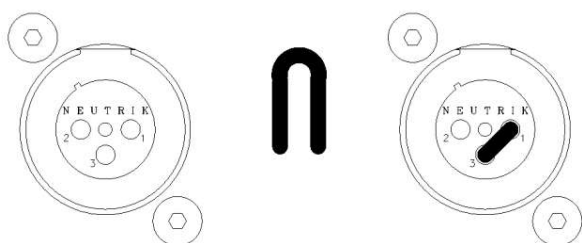

Figure 7: XLR connector without and with jumper accessory

The **MOON 810LP** is equipped with a 5-point version of our **M-Octave Damping** system, whereby the main audio circuit board is coupled to the chassis using an 5-point floating suspension that is designed to eliminate distortion caused by the “Microphonic effect” of airborne vibrations. All audio connectors are directly mounted to this main audio circuit board. As a result, a dual-layered rear panel is required to accommodate this suspension, with the outer layer affixed to the **810LP**’s chassis and the inner layer – with the audio connectors – affixed to the main audio circuit board. *Consequently, when you connect cables to (or disconnect cables from) the 810LP, this inner rear panel will move slightly – This is normal.* These rear panel layers are completely independent of each other, only coming into physical contact when either connecting or disconnecting cables.

Balanced Operation

When using an unbalanced interconnect, the audio signal runs through both the center wire and the shield/ground wire. Any noise picked up by this interconnect (ie. nearby magnetic fields such as an AC power cord) will be reproduced by the integrated amplifier, then heard through the loudspeakers. Conversely, a balanced interconnect has three separate conductors; one for the ground and two for the actual signal. These two signals are identical except that one is 180 degrees out of phase with the other. For example, when one conductor is carrying a signal of +2 Volts, the other will be carrying a signal of -2 Volts. When these two inverted signals on a balanced line are output from the **MOON 810LP**, any noise picked up by the interconnect will be eliminated since a differential circuit amplifies only the difference between these two signals: Noise on a balanced interconnect will be equal on both conductors and therefore cancel out.

Operating the 810LP

We recommend that you leave your **MOON 810LP** dual-mono phono preamplifier powered up at all times to maintain optimal performance. When you plan to be away from your home for a few days, powering off the preamplifier may not be a bad idea. Once fully “broken-in”, please keep in mind that your **810LP** will require several hours of playing time before it reaches its peak performance after you’ve powered it up again.

Turning on your MOON 810LP for the first time

Prior to turning the phono preamplifier on for the first time, make sure that every cable is properly connected to avoid any problems. Flick the main rocker switch, located on the rear panel, labeled “POWER” to the ‘1’ (on) position to place your **740P** in to standby mode. Next, briefly press the push button labeled “Standby” located on the front panel. You will hear a very faint click sound confirming that everything is in order. The blue LED on the front panel will illuminate, indicating that the **810LP** is now powered up and ready for use.

On and Off Sequence

To avoid having any annoying noises (ie. “thumps” and “pops”) emanate from your speakers when powering your **810LP** on or off, you should always power up your **810LP** phono preamplifier before powering up your preamplifier or integrated amplifier. As well, always power down your **810LP** after powering down your preamplifier or integrated amplifier.

Remote Operation

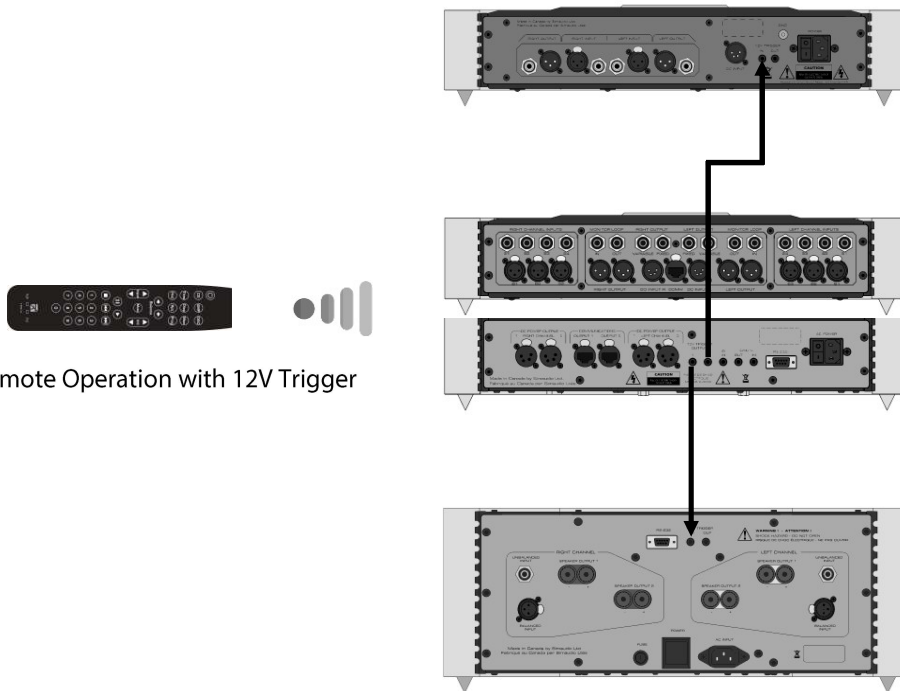

Figure 8: Remote Operation with 12V Trigger

In figure 8 we have a **810LP** Phono Preamp, **850P** Preamp, and **870A** Power Amplifier connected together via their respective 12V triggers; The two 12V trigger outputs on the **850P** are connected to the 12V trigger inputs on both the **810LP** (using a 1/8" mini-jack cable) and **870A**. When you turn on the **850P** via remote control (or its Standby button), both the **810LP** and **870A** will turn on automatically. The same rule applies when you put the **850P** into Standby mode.

Specifications

Configuration	Fully balanced differential, dual-mono
Inputs: Balanced / Single-ended	1 pair (XLR) / 1 pair (RCA)
Input Impedance – Adjustable	64 settings from 12.1Ω to 47kΩ
Input Capacitance – Adjustable	16 settings from 0pF to 1120pF
Gain Level – Adjustable	16 settings from 40dB to 70dB
Outputs: Balanced / Single-ended	1 pair (XLR) / 1 pair (RCA)
Input overload @ 40dB gain	200mV RMS (XLR) / 100mV RMS (RCA)
Input overload @ 55.5dB gain	30mV RMS (XLR) / 15mV RMS (RCA)
Input overload @ 60dB gain	20mV RMS (XLR) / 10mV RMS (RCA)
Input overload @ 65dB gain	10mV RMS (XLR) / 5mV RMS (RCA)
Input overload @ 70dB gain	5mV RMS (XLR) / 2.5mV RMS (RCA)
Signal-to-noise Ratio (full scale @40dB gain)	115dBr
Signal-to-noise Ratio (full scale @55.5dB gain)	108dBr
Signal-to-noise Ratio (full scale @60dB gain)	105dBr
Signal-to-noise Ratio (full scale @65dB gain)	100dBr
Signal-to-noise Ratio (full scale @70dB gain)	95dBr
Frequency Response – RIAA & IEC Curve	20Hz - 20kHz (± 0.1dB)
Output Impedance	50Ω
IEC Curve Effect	- 7dB @ 10Hz
Crosstalk @ 1kHz	- 106dB
Intermodulation Distortion	0.001%
THD (20Hz - 20kHz)	0.0008%
Power Consumption @ idle	10 W
AC Power Requirements	120V / 60Hz or 240V / 50Hz
Shipping Weight	40 lb / 18 kg
Dimensions (W x H x D, inches / cm)	18.75 x 4.0 x 16.8 / 47.6 x 10.2 x 42.7

Balanced Input Pin Assignment:

Pin 1	Ground
Pin 2	Positive
Pin 3	Negative



Fuse Replacement:

For the 120V version use a 0.2A slow blow (5 x 20mm size).

For the 230V version use a 0.1A slow blow (5 x 20mm size)