

*Sonus faber*<sup>®</sup>

ARTISAN OF SOUND

**DUETTO**

STEREO WIRELESS SPEAKER

QUICK START GUIDE

DUETTO

3-YEAR  
WARRANTY

Register Duetto on [sonusfaber.com](https://sonusfaber.com)  
to extend your product warranty.

*Sonus faber*  
ARTISAN OF SOUND

# 1 CONTENUTO DELL'IMBALLO

IT

## 1.1

Registra Duetto su sonusfaber.com per ottenere un'ulteriore copertura di garanzia di 1 anno!

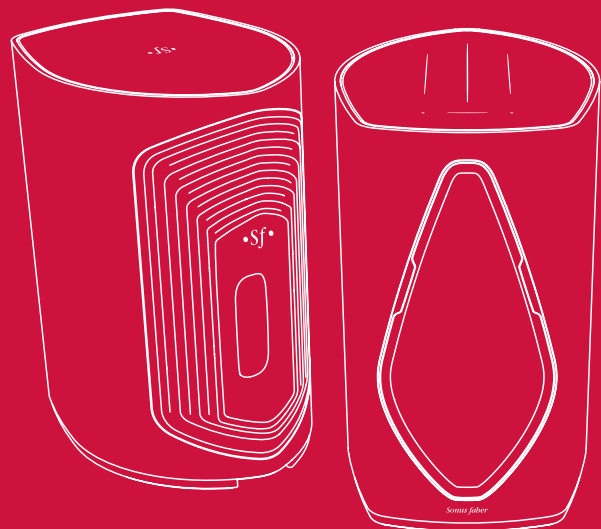

CONNECT DUETTO TO YOUR WI-FI NETWORK AND START LISTENING TO YOUR MUSIC BY FOLLOWING THIS MANUAL.

FOR FURTHER INFORMATION AND TROUBLESHOOTING, PLEASE VIEW THE INTERACTIVE MANUAL AND INSTALLATION VIDEO AT:

[www.sonusfaber.com/en/products/duetto/](http://www.sonusfaber.com/en/products/duetto/)

Further information at: [www.sonusfaber.com](http://www.sonusfaber.com)

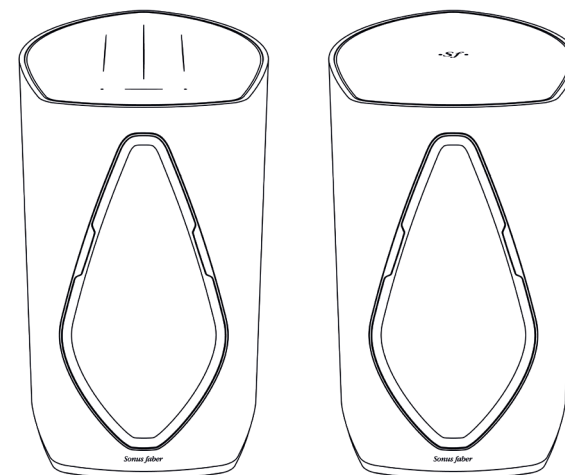

Diffusori con mascherine in tessuto rimovibili

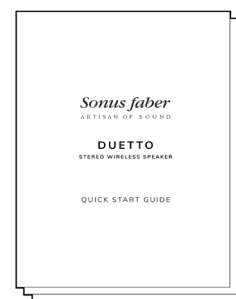

Guida all'installazione



Telecomando



Coperture protettive



Cavi di alimentazione

## 2 CONTROLLI

### 2.1 Diffusore

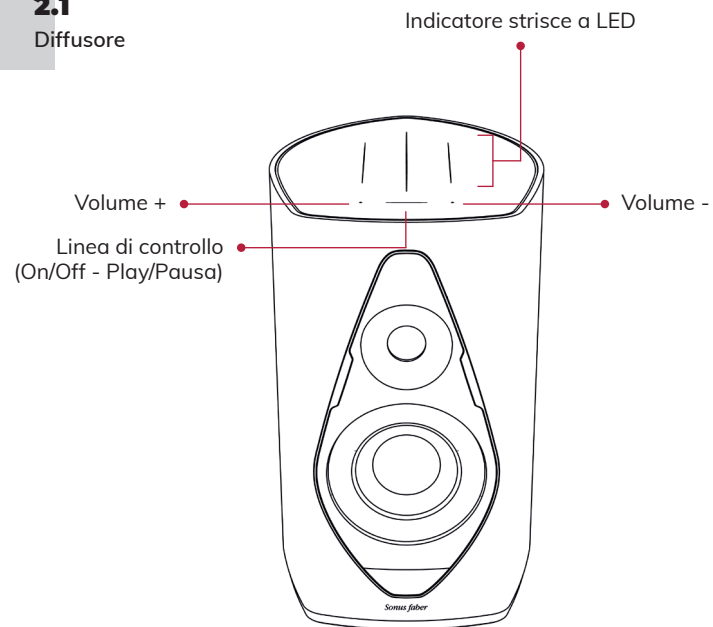

### 2.2 Telecomando

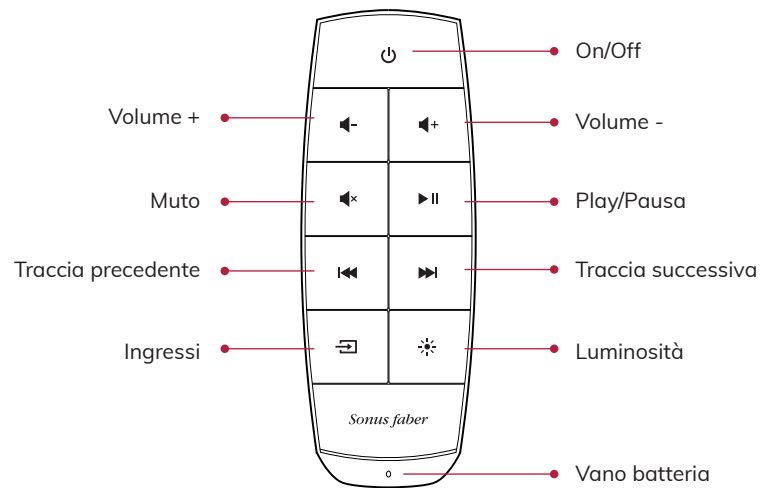

## 3 INGRESSI

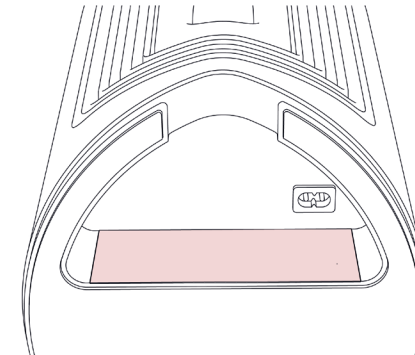

### 3.1 Diffusore Master

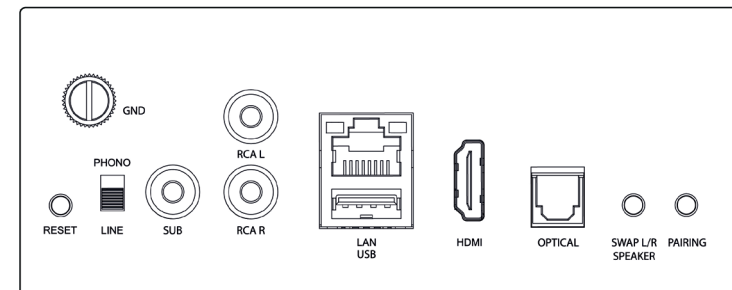

### 3.2 Diffusore Satellite

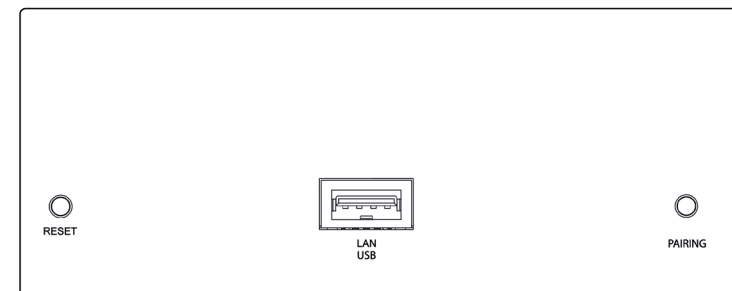

# 4 INIZIA

## 4.1

Posizionare Duetto Master e Satellite dove si intende utilizzarli, quindi connettere il cavo di alimentazione.

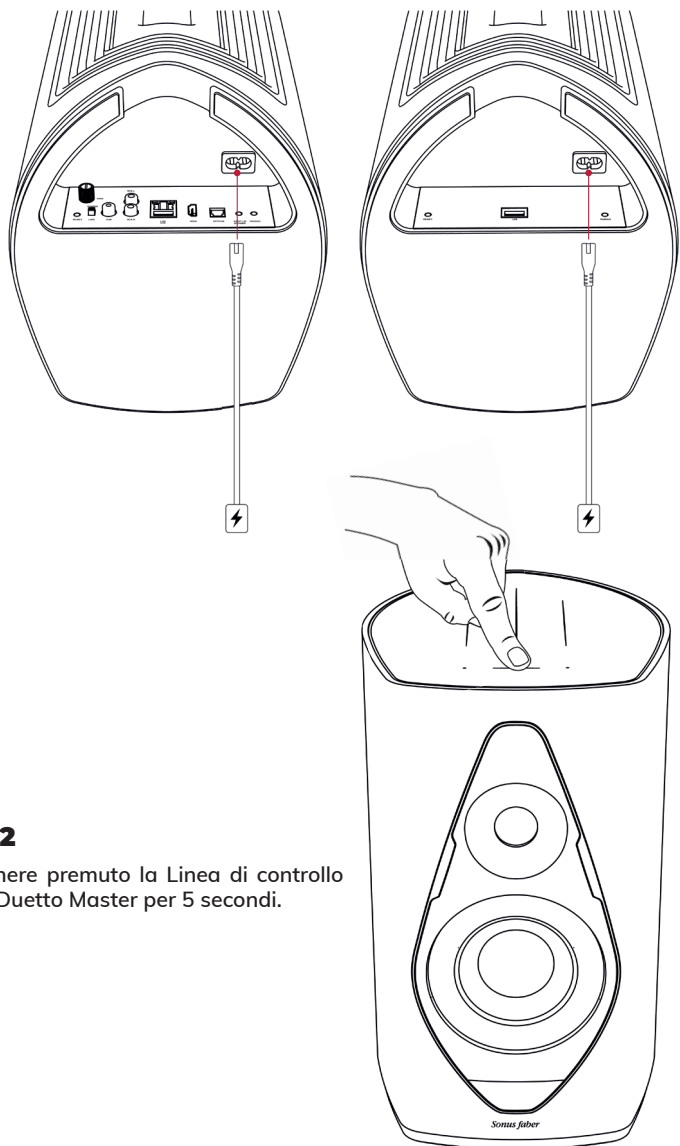

## 4.2

Tenere premuto la Linea di controllo di Duetto Master per 5 secondi.

## 4.3

Accoppiare Master e Satellite.

Premere il pulsante "Pairing" sul retro di un diffusore. Entro 30 secondi premere il pulsante "Pairing" sul retro dell'altro diffusore.

Diffusore Master

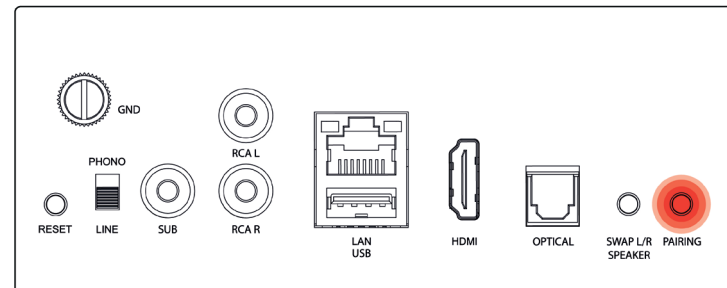

Diffusore Satellite

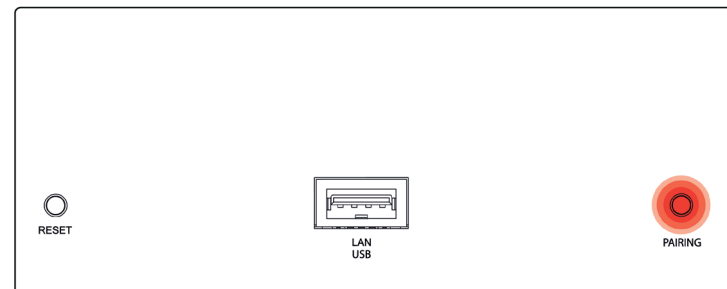

Un'animazione luminosa indicherà l'avvenuto accoppiamento.

# 5 POSIZIONAMENTO

## 5.1

Posizionamento a destra e sinistra.

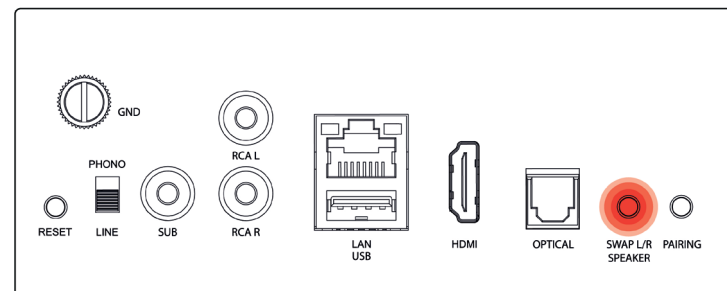

Per impostazione predefinita, l'unità Master è configurata per essere il diffusore di sinistra. Per utilizzarlo come diffusore di destra è necessario premere il pulsante "SWAP L/R SPEAKER" sulla scheda di ingresso sul retro di Duetto Master. Un'animazione luminosa indicherà l'inversione di posizionamento.

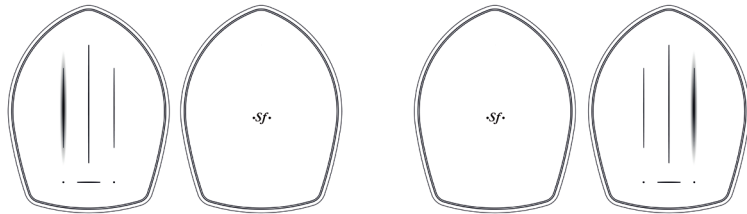

## 5.2

### Posizionamento nella stanza.

Dimensioni della stanza consigliate per un ascolto stereo ottimale: dai 20m<sup>2</sup> ai 60m<sup>2</sup>  
Distanze minime consigliate per il posizionamento dei diffusori: 2m:

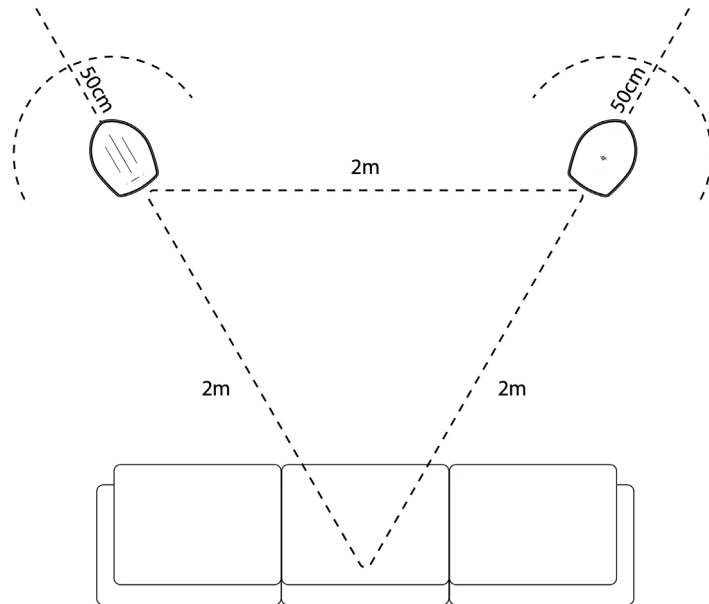

Dopo aver collegato Duetto alla rete Wi-Fi, per garantire la massima versatilità d'ascolto all'interno della stanza i parametri EQ possono essere adattati tramite la pagina web di configurazione. (Capitolo 9)

Per impostazione predefinita, gli speaker sono configurati per essere utilizzati a distanza dalle pareti (50cm). Se i diffusori sono posizionati vicini alle pareti, selezionare Room Placement "Near the wall" nella pagina web di configurazione

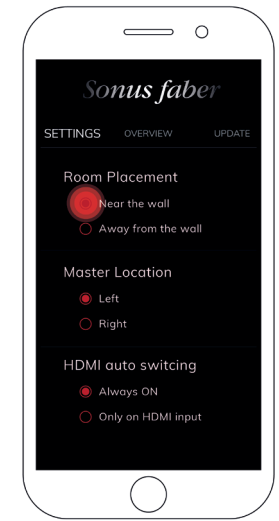

## 6 CONFIGURAZIONE WI-FI

Connettere il proprio dispositivo alla stessa rete Wi-Fi alla quale è connesso Duetto. Quanto la Linea di controllo lampeggerà di colore bianco, i diffusori sono pronti per essere configurati.

Duetto supporta entrambe le bande Wi-Fi 2.4Ghz e 5.2Ghz

### 6.1

#### Dispositivi iOS

##### Utilizzando la configurazione Wi-Fi

- Aprire Impostazioni sul proprio dispositivo IOS
- Impostazioni Wi-Fi
- Selezionare Duetto-xxxxxx all'interno di Configura un nuovo diffusore AirPlay
- Selezionare Prossimo, quindi Fatto

##### Utilizzando l'app Home

- Installare/Aggiornare l'app Home
- Aprire l'app Home
- Selezionare Aggiungere Accessorio
- Seguire il wizard per configurare il Wi-Fi

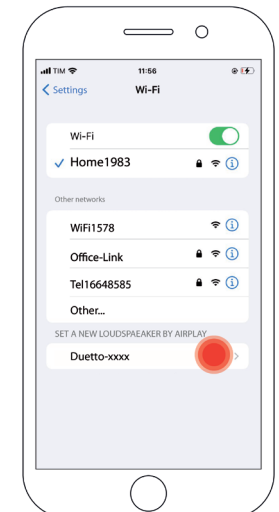

**6.2**

**Dispositivi Android™**

- Installare/Aggiornare l'app Google Home
- Aprire l'app Google Home
- Selezionare + in alto a sinistra
- Selezionare Configura nuovo dispositivo
- Seguire il wizard per configurare il Wi-Fi

**6.3**

**Ethernet**

- Connetter il proprio router a Duetto tramite un cavo Ethernet

Per maggiori dettagli e risoluzione di problemi consulta il manuale interattivo e il video di installazione presso [www.sonusfaber.com/en/products/Duetto/](http://www.sonusfaber.com/en/products/Duetto/)

**7 RIPRODURRE LA MUSICA**

**7.1**

**App di streaming**

Assicurarsi che il colore della Linea di controllo sia bianco. In caso contrario, andare alla sezione 7.2  
 Accedere all'app desiderata e scegliere Duetto come diffusore desiderato  
 La luce colorata della Linea di controllo ora cambierà in base al servizio di streaming utilizzato.

- AirPlay (bianco)
- Chromecast built-in (giallo)
- Spotify (verde)
- Tidal (azzurro/turchese)
- Roon (viola)

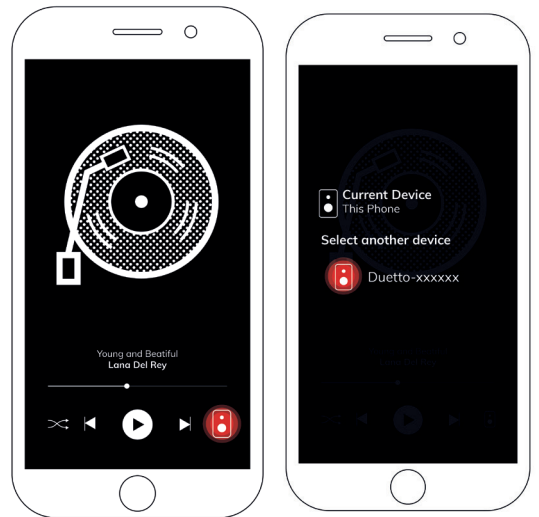

**7.2**

**Selezionare l'ingresso**

Modificare l'ingresso finché la Linea di controllo indicherà il colore dell'ingresso desiderato. Scorre dal centro verso destra della Linea di controllo finché essa non apparirà del colore dell'ingresso desiderato. L'input può essere modificato anche da remoto utilizzando il telecomando.

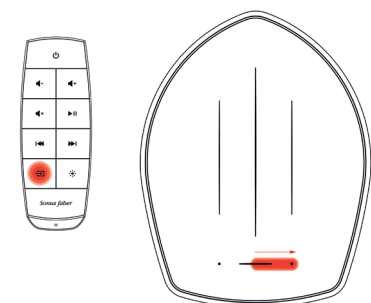

**7.3**

**Bluetooth**

- Modificare l'ingresso finché la Linea di controllo comincerà a lampeggiare di blu
- All'interno delle impostazioni Bluetooth del proprio dispositivo selezionare la ricerca di un nuovo dispositivo
- Selezionare Duetto-xxxxxx nella lista di dispositivi Bluetooth disponibili
- Quando la luce blu della Linea di controllo smetterà di lampeggiare Duetto sarà pronto per riprodurre la musica

**7.4**

**Ingressi fisici**

Modificare l'ingresso finché la Linea di controllo indicherà il colore dell'ingresso desiderato:

- HDMI (arancione)
- Optical (fucsia)
- Line/Phono (Magenta)

Assicurarsi che il dispositivo analogico sia configurato correttamente  
 Necessità dei dispositivi:

- HDMI ARC: selezionare la configurazione del segnale TV PCM/Stereo
- Phono stage: Testine (MM) phono con output dai 2.4mV fino ai 5.0mV. Assicurarsi di selezionare Phono nella scheda di ingresso sul retro di Duetto. Line In è dedicata per segnale ad alto livello come i riproduttori CD
- Optical: utilizzare l'opzione Optical. Assicurarsi che la TV sia configurata su un segnale audio digital in formato PCM

## 8 SUBWOOFER

Duetto da la possibilità di aggiungere al sistema un subwoofer esterno. Per farlo, connettere un cavo RCA dal subwoofer all'ingresso di Duetto Master denominato "Sub Out". Il subwoofer sarà individuato automaticamente e aggiunto al sistema. Per adattarlo al meglio alla stanza le opzioni di regolazione gain, cut-off frequency e delay sliders sono presenti all'interno della pagina web di configurazione. (Capitolo 9).

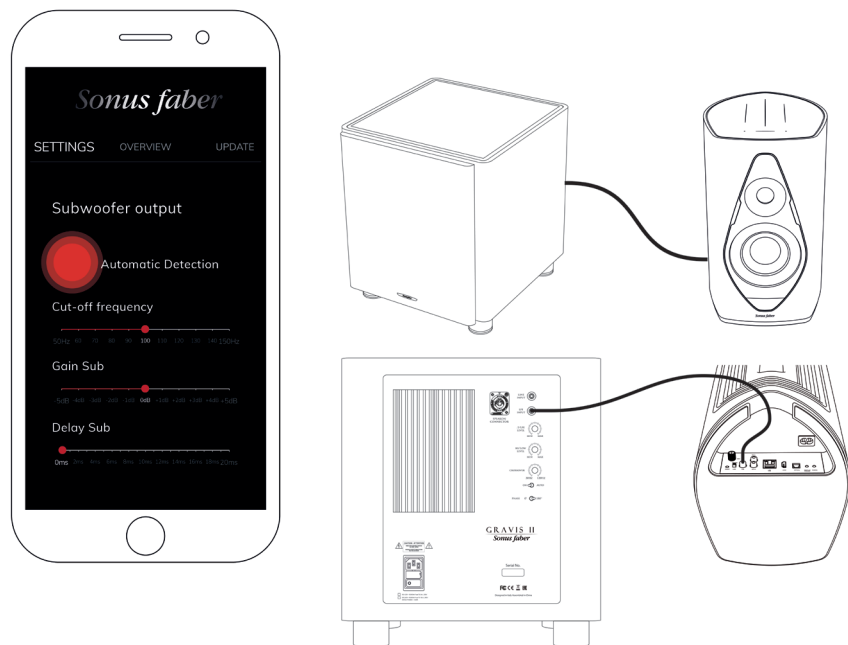

## 9 PAGINA WEB DI CONFIGURAZIONE

Per un'installazione interamente personalizzabile accedere alla pagina web di configurazione. Personalizzazioni disponibili: Nome del Diffusore, Power Sleep Timer, Startup Volume Limit, Network Type, Equalization Settings, Room Placement, Master Location, Subwoofer output, HDMI Auto Switching.

- Connettersi alla rete Wi-Fi (Capitolo 6)
- Scannerizzare il QR code presente sul retro della Quick Start Guide



Il QR code deve essere scannerizzato solo dopo aver connesso Duetto alla rete Wi-Fi.  
Non scannerizzarlo se la rete Wi-Fi non è disponibile.  
In alternativa, inserire nel proprio browser l'indirizzo presente sotto il QR code.

## 1 CONTENT OF THE PACKAGE

### 1.1

Register Duetto on sonusfaber.com to get an additional 1-year warranty coverage!

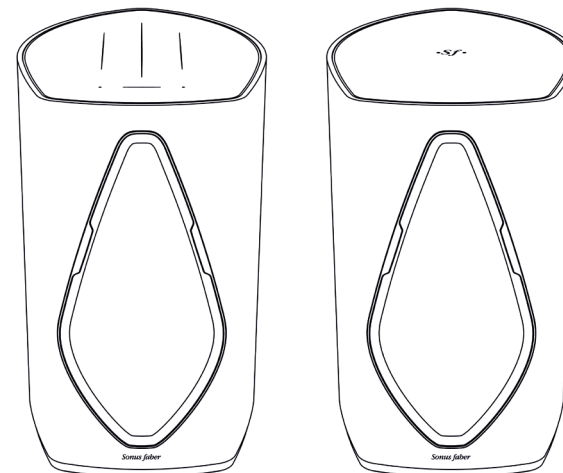

Speakers with removable fabric grilles

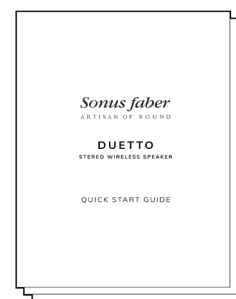

Installation guide

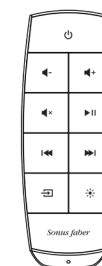

Remote control



Protective covers



Power cords



## 2 CONTROLS

### 2.1 Speaker

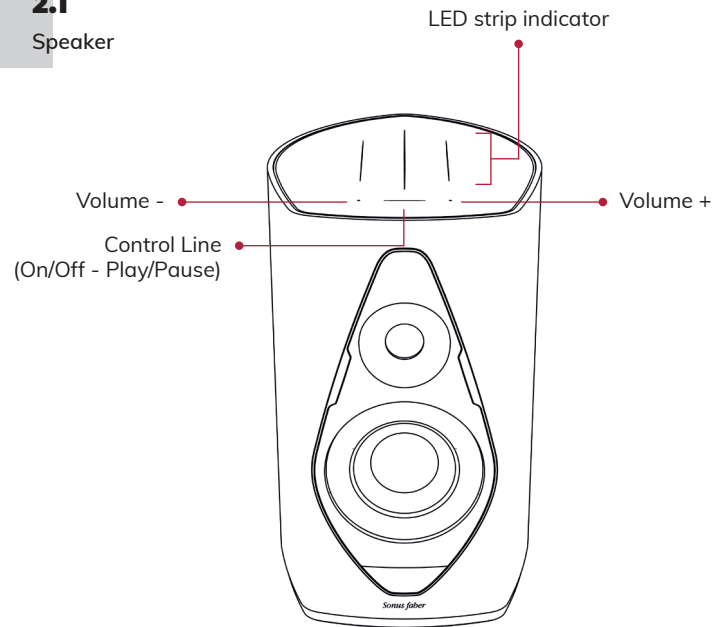

### 2.2 Remote Control

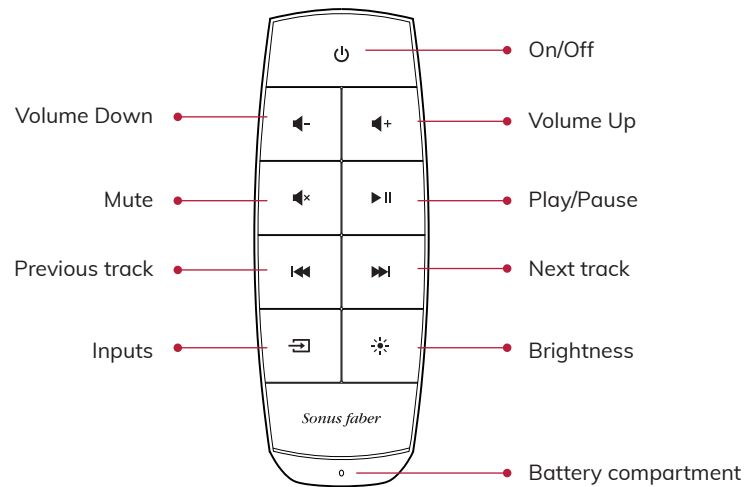

## 3 INPUTS

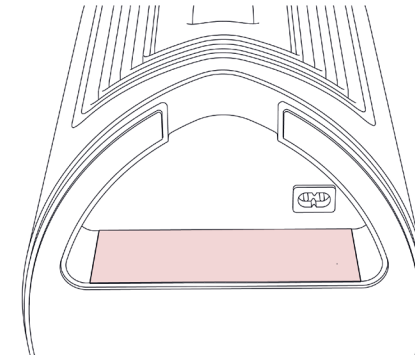

### 3.1 Master Speaker

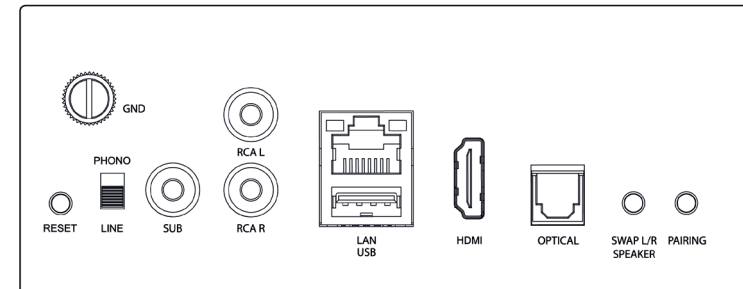

### 3.2 Satellite Speaker

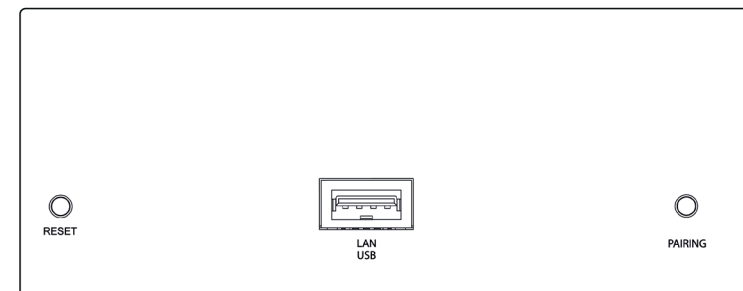

# 4 START

## 4.1

Place the Master and Satellite Duetto where you want to use them and connect the power cord.

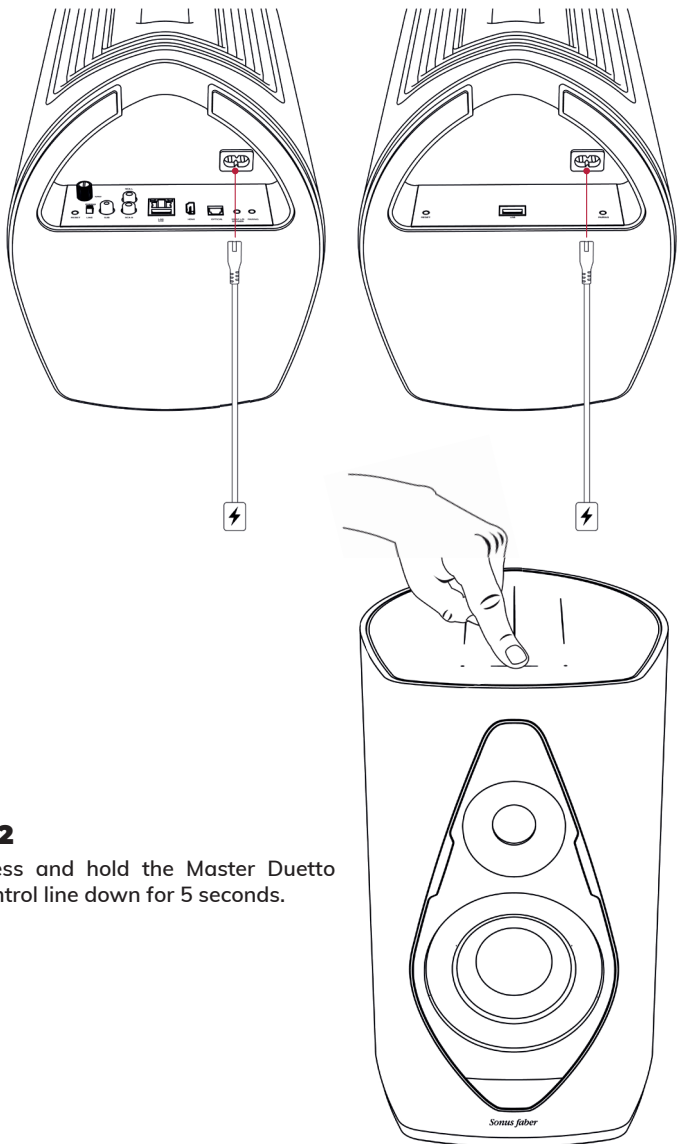

## 4.2

Press and hold the Master Duetto control line down for 5 seconds.

## 4.3

Pair the Master and Satellite.

Press the "Pairing" button on the back of a speaker. Press the "Pairing" button on the back of the other speaker within 30 seconds.

Master Speaker

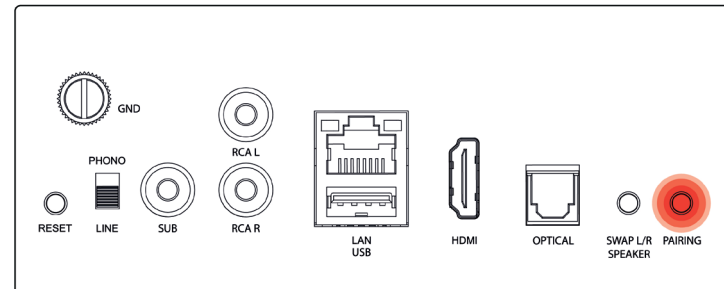

Satellite Speaker

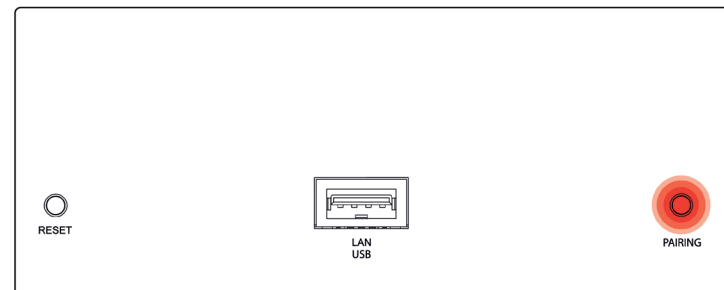

Flashing lights will indicate that the speakers are paired.

# 5 POSITIONING

## 5.1

Right and left positioning.

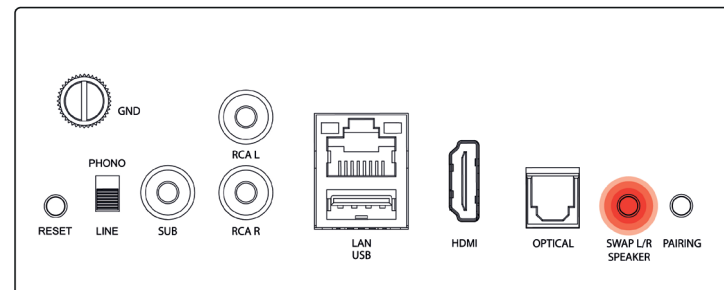

EN

The Master is set as the left speaker by default. Press the "SWAP L/R SPEAKER" button on the input board on the back of the Master Duetto to use it as the right speaker. Flashing lights will indicate that the reversed position.

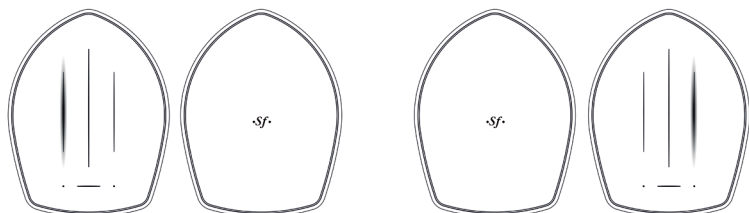

## 5.2

### Placement in the room

Recommended room size for optimal stereo sound: from 20m<sup>2</sup> to 60m<sup>2</sup>  
 Minimum recommended distance for speaker positioning: 2 m

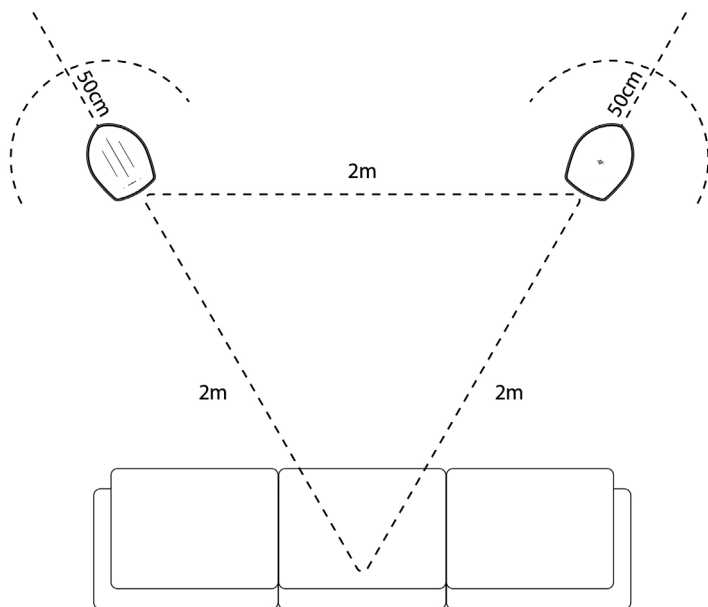

To guarantee maximum listening versatility in the room, EQ settings can be adjusted on the set-up web page after connecting Duetto to the Wi-Fi network. (Chapter 9)

Speakers are set to be used away from walls (50cm) by default. If speakers are placed near a wall, select Room Placement "Near the wall" in the set-up web page.

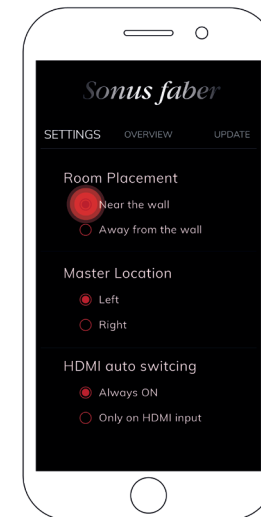

EN

## 6 WI-FI SETUP

Connect your device to the same Wi-Fi network that the Duetto is connected to. The speakers are ready to be set when the Control line flashes white. Duetto supports both 2.4Ghz and 5.2Ghz Wi-Fi bands.

### 6.1

#### iOS devices

##### Using Wi-Fi settings

- Open settings on your iOS device
- Wi-Fi settings
- Select Duetto-xxxxxx in Set-up a new AirPlay speaker
- Select Next, then Done

##### Using the Home app

- Install/Update the Home app
- Open the Home app
- Select Add Accessory
- Follow the wizard to set up Wi-Fi

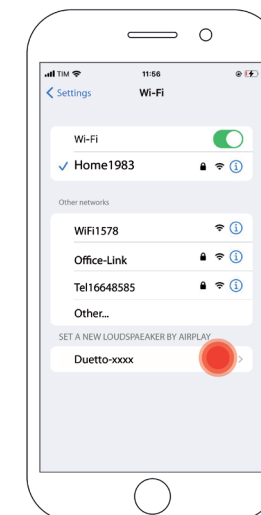

## 6.2

### Android™ Devices

- Install/Update the Google Home app
- Open the Google Home app
- Select + at the top left
- Select Set-up a new device
- Follow the wizard to set up Wi-Fi

## 6.3

### Ethernet

- Connect your router to Duetto via Ethernet cable

For further information and troubleshooting, please view the interactive manual and installation video at: [www.sonusfaber.com/en/products/Duetto/](http://www.sonusfaber.com/en/products/Duetto/)

# 7 PLAY MUSIC

## 7.1

### Streaming Apps

Make sure the Control line colour is white. Otherwise, please go to section 7.2. Turn on the chosen app and select Duetto with the required speaker. The Control line coloured light will now change according to the streaming service used.

- AirPlay (white)
- Chromecast built-in (yellow)
- Spotify (green)
- Tidal (light blue/turquoise)
- Roon (purple)

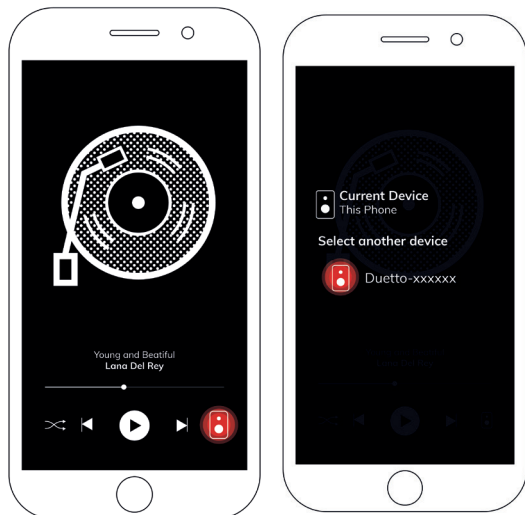

## 7.2

### Select the input

Change the input until the Control line indicates the required input colour. Scroll from the centre to the right of the Control line until the required input colour appears. The input can also be changed remotely using the remote control.

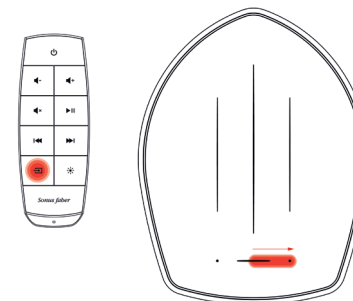

## 7.3

### Bluetooth

- Change the input until the Control line starts to flash blue
- Select search for a new device in your device Bluetooth settings
- Select Duetto-xxxxxx from the list of available Bluetooth devices
- Duetto is ready to play music when the blue Control line light stops flashing

## 7.4

### Physical Inputs

Change the input until the Control line indicates the required input colour

- HDMI (orange)
- Optical (fuchsia)
- Line/Phono (magenta)

Make sure the analog device is correct set up. Device requirements::

- HDMI ARC: select the TV PCM/Stereo signal set-up
- Phono stage: Cartridges (MM) with output from 2.4mV to 5.0mV. Make sure you select Phono in the input board on the back of Duetto. Line In is reserved to high level signals such as CCD players
- Optical: use the Optical option. Make sure the TV is set up with a PCM format digital audio signal

## 8 SUBWOOFER

Duetto lets you add an external subwoofer to the system. To do this, connect an RCA cable from the subwoofer to the Master Duetto input called "Sub Out". The subwoofer will be automatically recognised and added to the system. Gain, cut-off frequency and delay slider options are found in the set-up web page to best adjust it to the room. (Chapter 9)

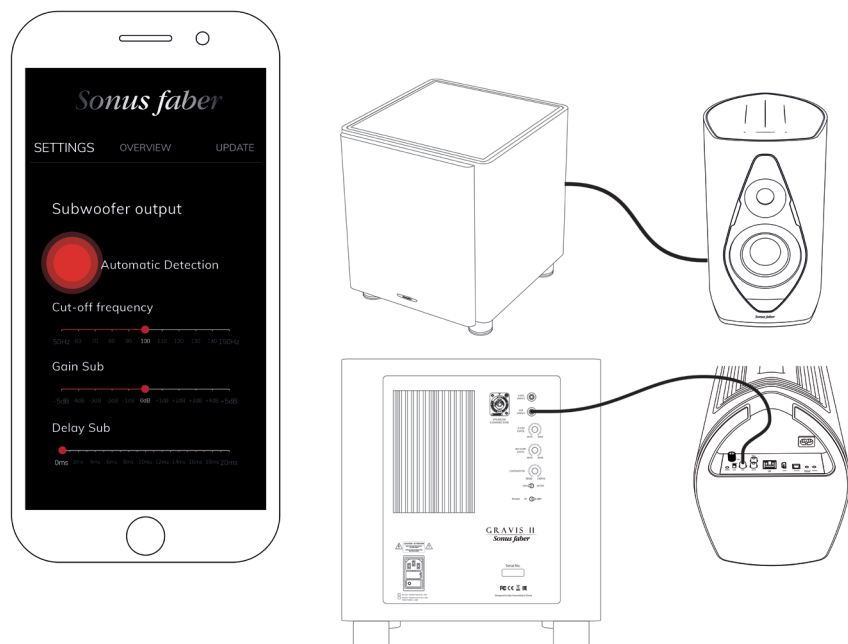

## 9 SET-UP WEB PAGE

Open the set-up web page to fully customise your installation. Available customisations: Speaker name, Power Sleep Timer, Startup Volume Limit, Network Type, Equalization Settings, Room Placement, Master Location, Subwoofer output, HDMI Auto Switching.

- Connect to the Wi-Fi network (Chapter 6)
- Scan the QR code on the back of the Quick Start Guide



Only scan the QR code after connecting Duetto to the Wi-Fi network. Do not scan it if the Wi-Fi network is not available. Alternatively, enter the address indicated under the QR code in your browser.

## 1 CONTENU DE L'EMBALLAGE

### 1.1

Enregistrer Duetto sur sonusfaber.com pour bénéficier d'une garantie supplémentaire d'un an!

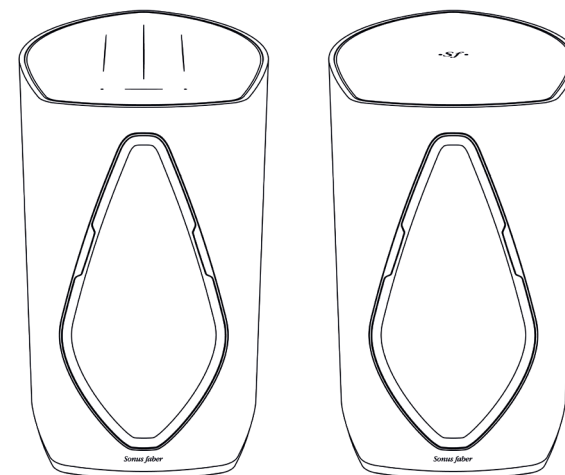

Enceintes avec housses en tissu amovibles

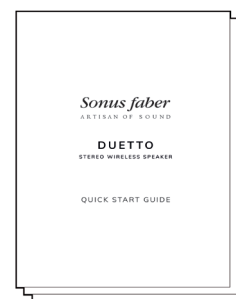

Guide d'installation



Télécommande



Couvertures de protection



Câbles d'alimentation

FR

## 2 CONTRÔLES

### 2.1 Enceintes

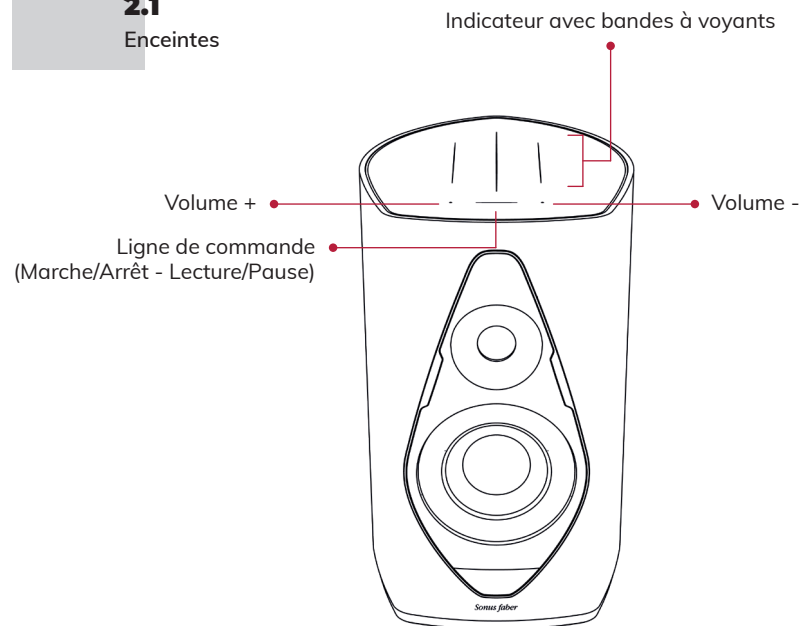

### 2.2 Télécommande

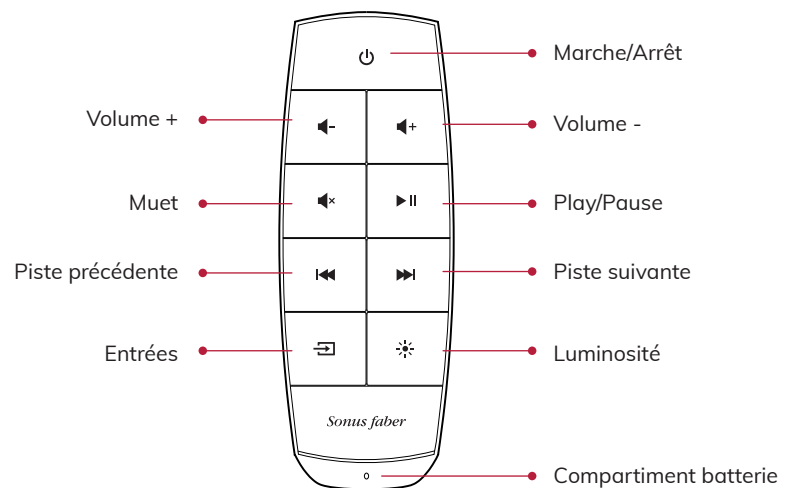

## 3 ENTRÉES

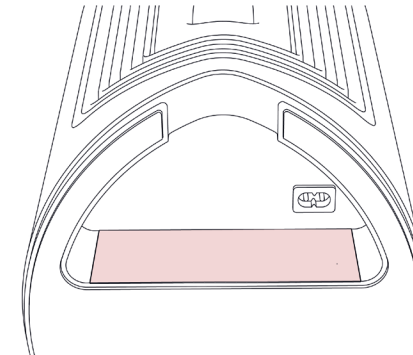

### 3.1 Enceinte Master

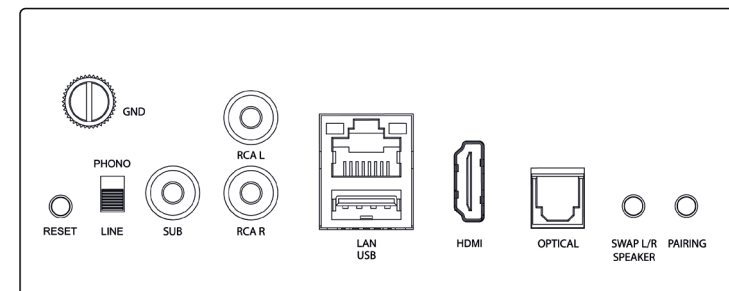

### 3.2 Enceinte Satellite

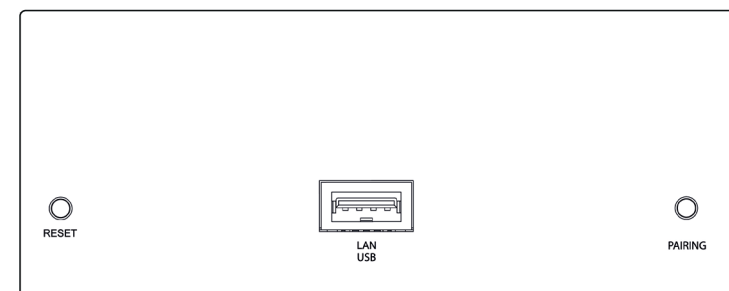

FR

## 4 COMMENCER

### 4.1

Placer Duetto Master et Satellite à l'endroit où ils seront utilisés, puis brancher le cordon d'alimentation.

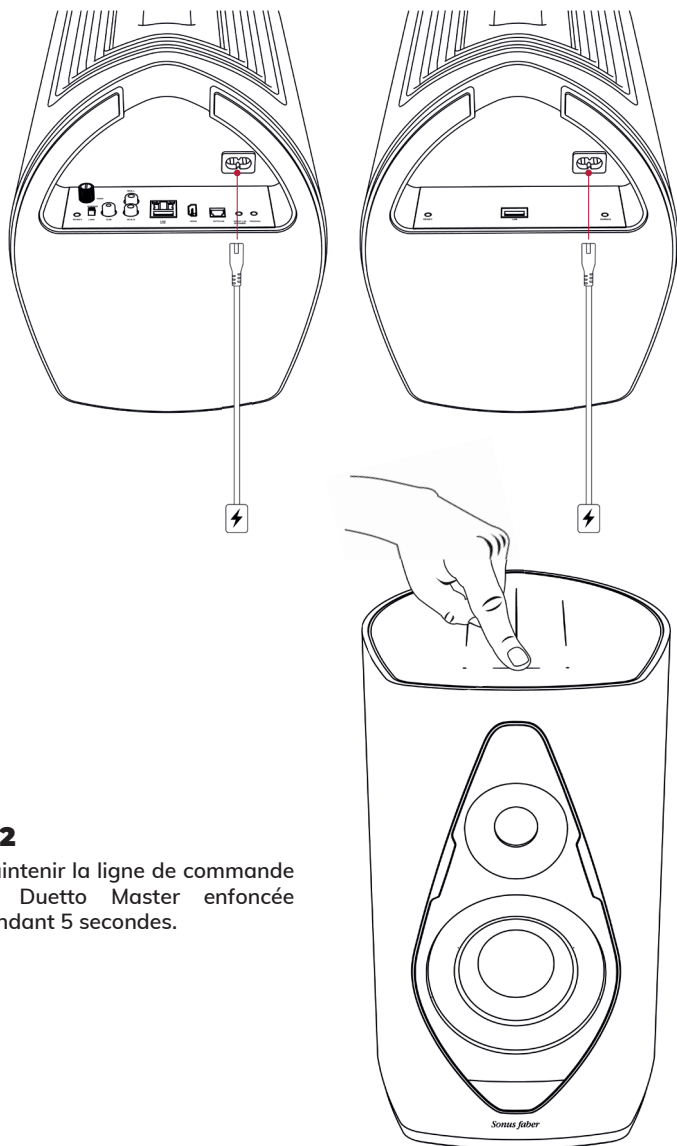

### 4.2

Maintenir la ligne de commande de Duetto Master enfoncée pendant 5 secondes.

### 4.3

Coupler Master et Satellite.

Appuyer sur le bouton « Pairing » situé à l'arrière d'un des enceintes. Puis, dans les 30 secondes, appuyer sur le bouton « Pairing » à l'arrière de l'autre enceinte.

Enceinte Master

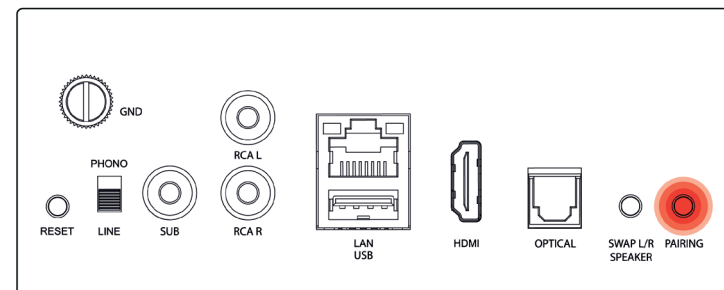

Enceinte Satellite

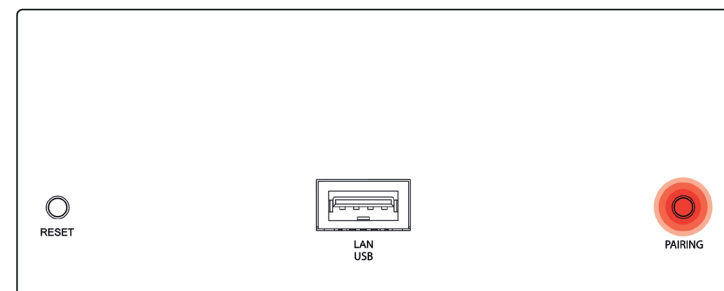

Une animation lumineuse indiquera la réussite du couplage.

## 5 POSITIONNEMENT

### 5.1

Positionnement à gauche et à droite.

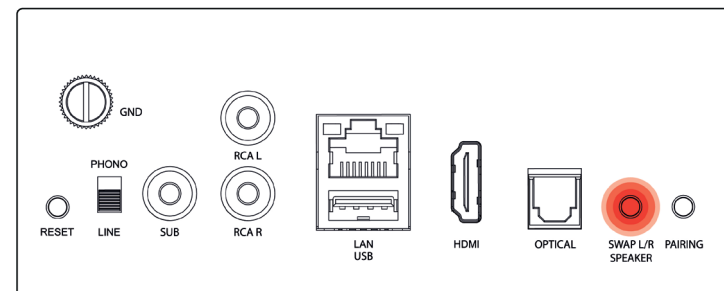

FR

Par défaut, l'unité Master est configurée pour être le enceinte de gauche. Pour l'utiliser comme enceinte de droite, appuyer sur le bouton «SWAP L/R SPEAKER» sur le panneau arrière située à l'arrière de Duetto Master. Une animation lumineuse indiquera que le positionnement a été inversé.

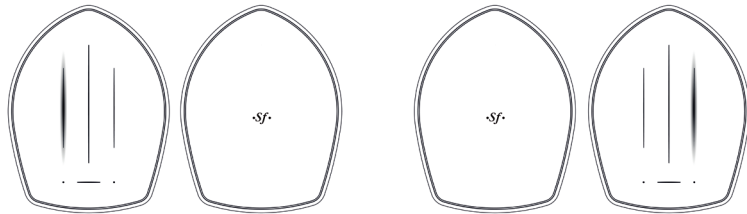

## 5.2

Positionnement dans la pièce.

Taille de la pièce recommandée pour une écoute stéréo optimale: 20 m<sup>2</sup> à 60 m<sup>2</sup>  
Distances minimums recommandées pour le positionnement des enceintes: 2 m

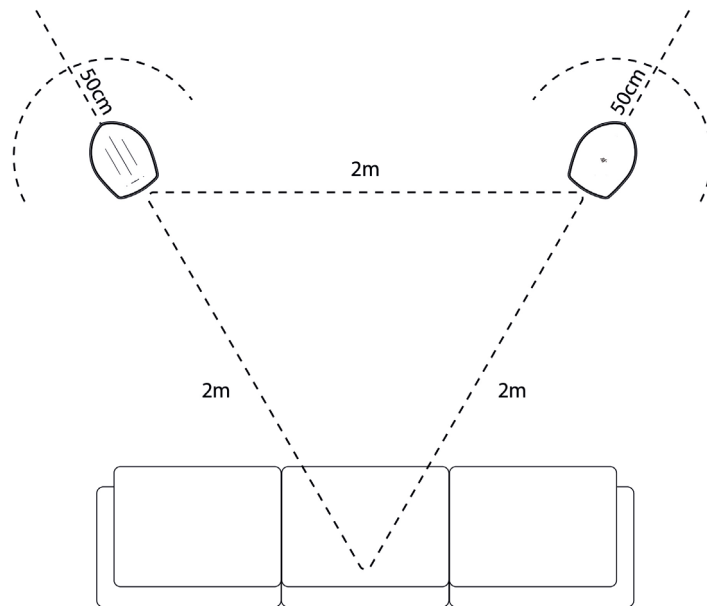

Après avoir connecté Duetto au réseau Wifi, afin d'assurer une polyvalence d'écoute maximum dans la pièce, les paramètres d'égalisation peuvent être adaptés en utilisant la page de configuration internet. (Chapitre 9).

Par défaut, les enceintes sont configurées pour être utilisées loin des murs (50 cm). Si les enceintes sont placées près de murs, sélectionner Room Placement « Near the wall » sur la page de configuration internet.

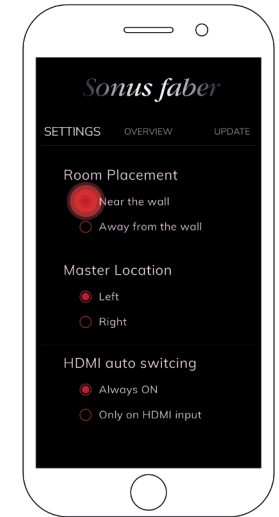

FR

# 6 CONFIGURATION WI-FI

Connecter l'appareil au même réseau Wifi que celui auquel Duetto est connecté. Lorsque la ligne de commande clignote en blanc, les enceintes sont prêtes à être configurées. Duetto prend en charge les bandes Wifi 2,4 Ghz et 5,2 Ghz.

## 6.1

Appareils iOS

### Utilisation de la configuration Wifi

- Ouvrir la section Réglages sur votre appareil iOS
- Réglages Wifi
- Sélectionner Duetto-xxxxxx sous Configurer une nouvelle enceinte AirPlay
- Sélectionner Suivant, puis Terminé

### Utilisation de l'application Home

- Installer/Mettre à jour l'application Home
- Ouvrir l'application Home
- Sélectionner Ajouter un accessoire
- Suivre l'assistant pour configurer le Wifi

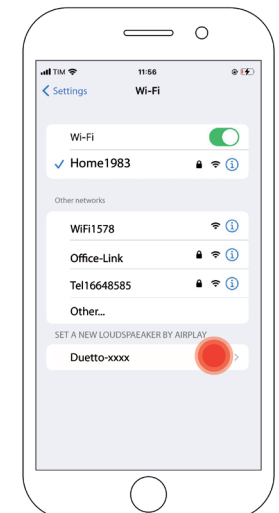



## 6.2

### Appareils Android™

- Installer/Mettre à jour l'application Google Home
- Ouvrir l'application Google Home
- Sélectionner + en haut à gauche
- Sélectionner Configurer un nouvel appareil
- Suivre l'assistant pour configurer le Wifi

## 6.3

### Ethernet

- Connecter le routeur à Duetto en utilisant un câble Ethernet

Pour plus de détails et des informations de dépannage, consulter le manuel interactif et la vidéo d'installation sur [www.sonusfaber.com/en/products/Duetto/](http://www.sonusfaber.com/en/products/Duetto/)

# 7 LIRE LA MUSIQUE

## 7.1

### Applications de streaming

S'assurer que la couleur de la ligne de commande soit blanche. Dans le cas contraire, passer à la section 7.2.

Accéder à l'application souhaitée et choisissez Duetto comme enceinte désirée.

La lumière colorée de la ligne de commande changera en fonction du service de streaming utilisé.

- AirPlay (blanc)
- Chromecast intégré (jaune)
- Spotify (vert)
- Tidal (bleu clair/turquoise)
- Roon (violet)

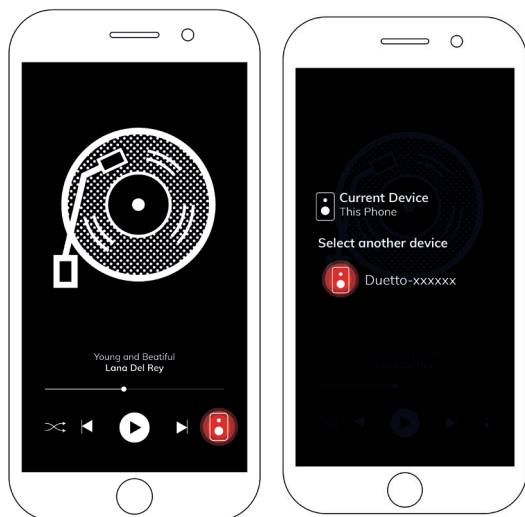

## 7.2

### Sélectionner l'entrée

Modifier l'entrée jusqu'à ce que la ligne de commande indique la couleur de l'entrée souhaitée. Faire défiler du centre vers la droite de la ligne de commande jusqu'à ce qu'elle apparaisse de la couleur de l'entrée désirée.

L'entrée peut également être modifiée à distance en utilisant la télécommande.

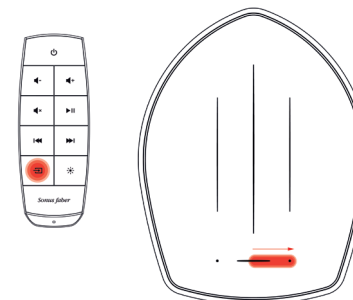

FR

## 7.3

### Bluetooth

- Modifier l'entrée jusqu'à ce que la ligne de commande commence à clignoter en bleu
- Dans les réglages Bluetooth de votre appareil, sélectionner Rechercher un nouvel appareil
- Sélectionner Duetto-xxxxxx dans la liste des appareils Bluetooth disponibles
- Lorsque la lumière bleue de la ligne de commande cesse de clignoter, Duetto est prêt à lire la musique

## 7.4

### Entrées physiques

Modifier l'entrée jusqu'à ce que la ligne de commande indique la couleur de l'entrée souhaitée:

- HDMI (orange)
- Optical (fuchsia)
- Line/Phono (magenta)

S'assurer que l'appareil analogique soit correctement configuré.

Requis pour les appareils:

- HDMI ARC : sélectionner la configuration du signal TV PCM/Stéréo
- Phono stage : cartouches (MM) phono avec sortie de 2,4 mV à 5,0 mV. S'assurer de sélectionner Phono sur le panneau arrière de Duetto. Line In est dédiée aux signaux de haut niveau tels que les lecteurs de CD
- Optical : utiliser l'option Optical. S'assurer que le téléviseur soit réglé sur un signal audio numérique au format PCM

## 8 SUBWOOFER

Duetto offre la possibilità d'aggiungere un subwoofer esterno al sistema. Per ce faire, connecter un câble RCA reliant le subwoofer à l'entrée de Duetto Master marquée « Sub Out ». Le subwoofer sera automatiquement détecté et ajouté au système. Pour mieux l'adapter à la pièce, les options de réglage des curseurs de gain, de fréquence de coupure et de délai, sont présentes sur la page de configuration internet. (Chapitre 9).

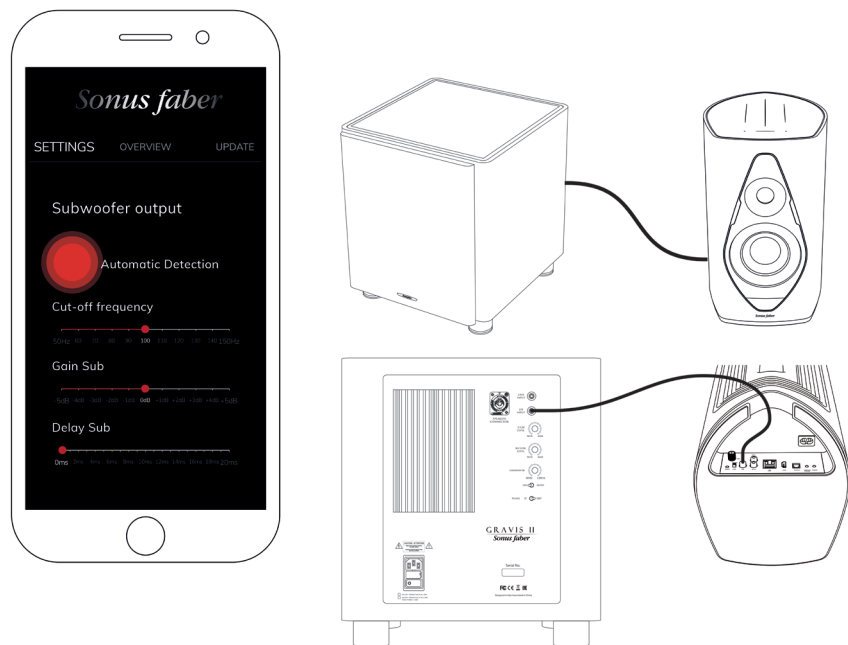

## 9 PAGE DE CONFIGURATION INTERNET

Pour une installation entièrement personnalisée, accéder à la page de configuration internet. Personnalisations disponibles: Nom de l'enceinte, Minuterie de mise en veille, Limite du volume de démarrage, Type de réseau, Paramètres d'égalisation, Positionnement dans la pièce, Emplacement principal, Sortie du caisson de basses, Commutation automatique HDMI.

- Se connecter au réseau Wifi (Chapitre 6)
- Scanner le code QR figurant au dos du Guide de démarrage rapide



Le code QR doit être scanné uniquement après avoir connecté Duetto au réseau Wifi  
Ne pas le scanner si le réseau Wifi n'est pas disponible  
Il est également possible de saisir l'adresse figurant sous le code QR du navigateur

## 1 VERPACKUNGSIHALT

### 1.1

Registrieren Sie auf Ihren Duetto auf [sonusfaber.com](https://sonusfaber.com), um eine Zusatzgarantie von 1 Jahr zu erhalten!

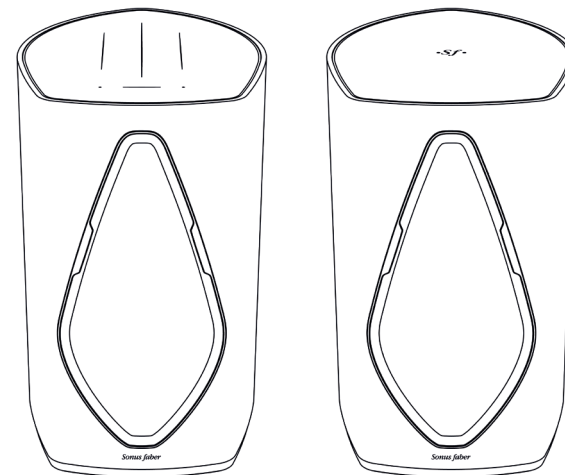

Lautsprecher mit abnehmbaren Stoffabdeckungen

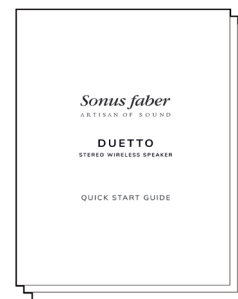

Installationsanleitung

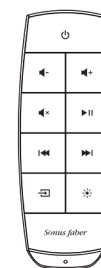

Fernbedienung



Schutzabdeckungen



Netzkabel

## 2 BEDIENELEMENTE

### 2.1 Lautsprecher

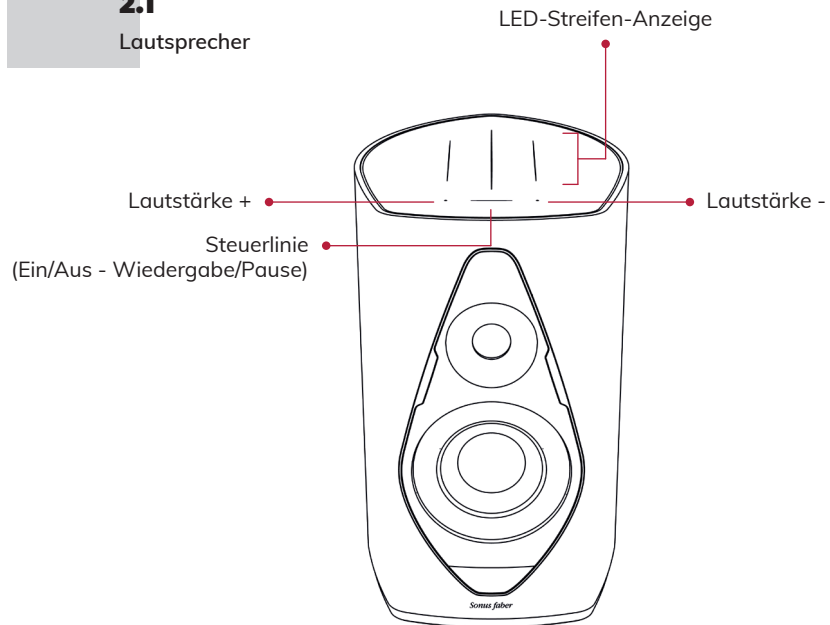

### 2.2 Fernbedienung

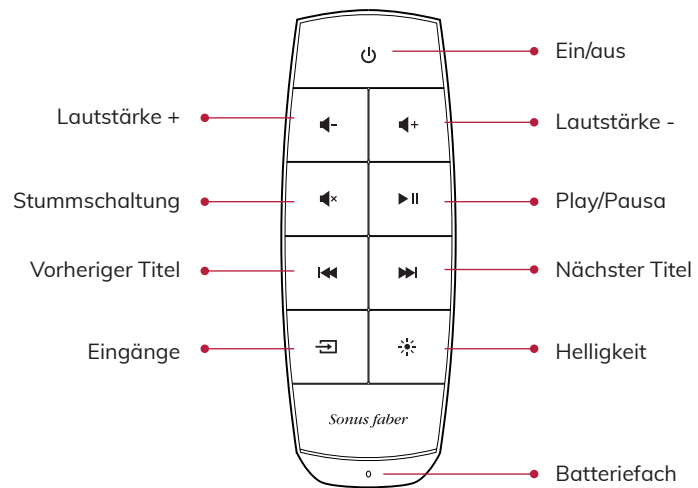

## 3 EINGÄNGE

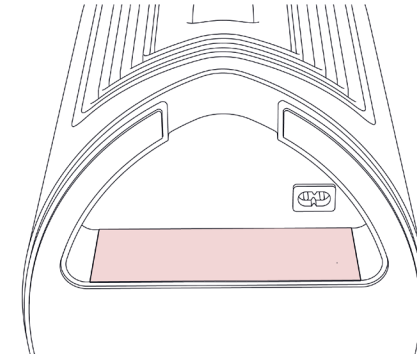

### 3.1 Master-Lautsprecher

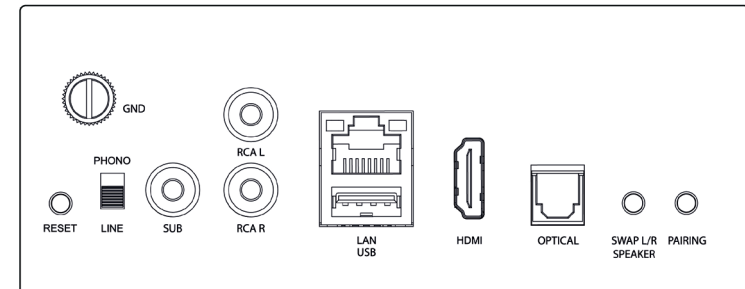

### 3.2 Satellite-Lautsprecher

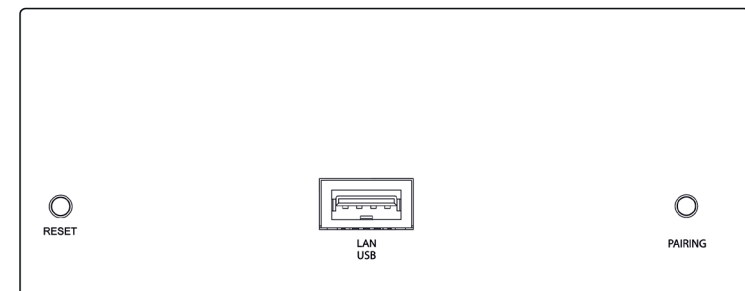

# 4 START

## 4.1

Stellen Sie den Duetto Master und den Satellite-Lautsprecher an dem gewünschten Platz auf und schließen Sie dann das Netzkabel an.

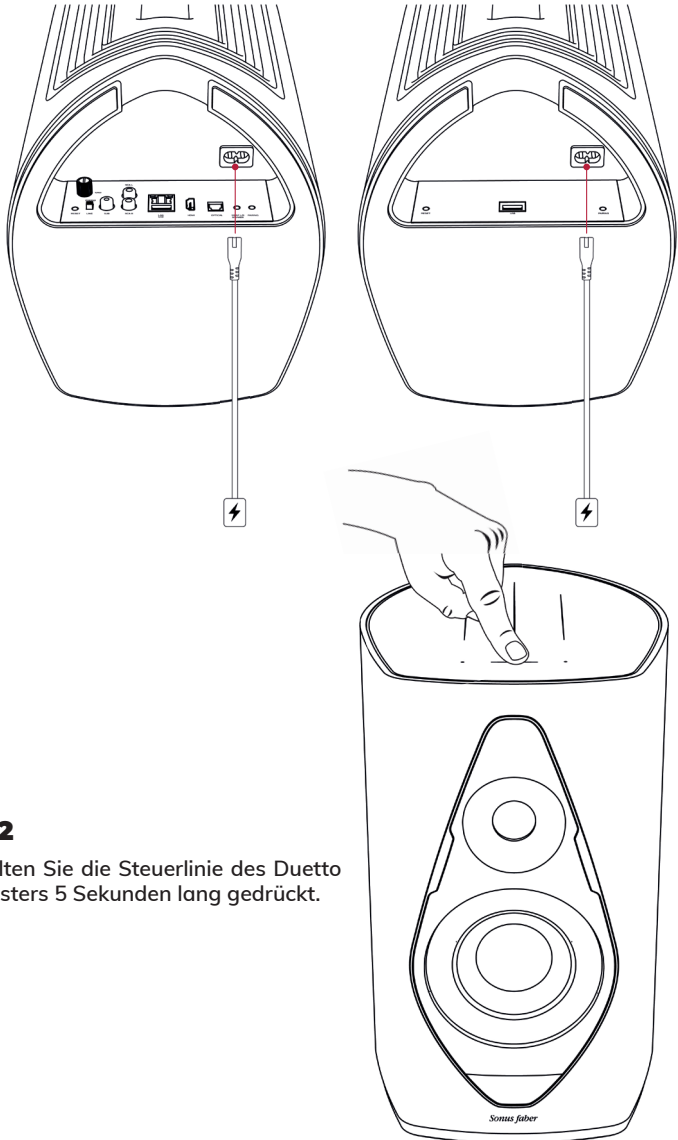

## 4.2

Halten Sie die Steuerlinie des Duetto Masters 5 Sekunden lang gedrückt.

## 4.3

Koppeln von Master und Satellite.

Drücken Sie die „Pairing“-Taste auf der Rückseite eines Lautsprechers. Drücken Sie innerhalb von 30 Sekunden die „Pairing“-Taste auf der Rückseite des anderen Lautsprechers.

Master-Lautsprecher

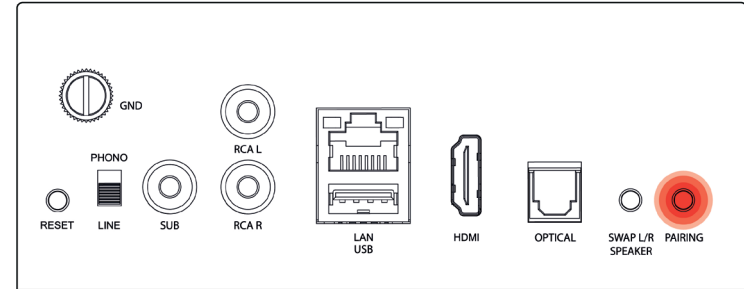

Satellite-Lautsprecher

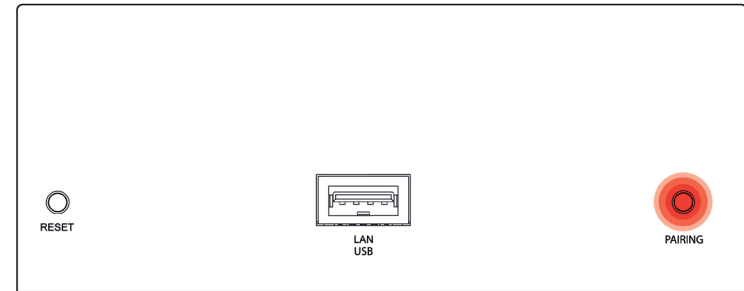

Eine Lichtanimation zeigt die erfolgreiche Kopplung an.

# 5 POSITIONIERUNG

## 5.1

Linke und rechte Positionierung.

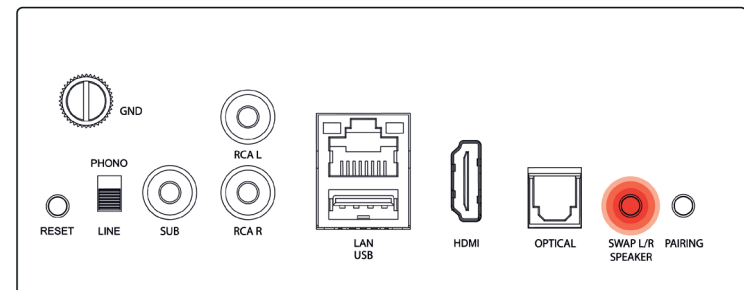

Standardmäßig ist das Master-Gerät als linker Lautsprecher konfiguriert. Um ihn als rechten Lautsprecher zu verwenden, drücken Sie die Taste „SWAP L/R SPEAKER“ auf der Eingangskarte auf der Rückseite des Duetto Master. Eine Lichtanimation zeigt die Umkehrung der Positionierung an.

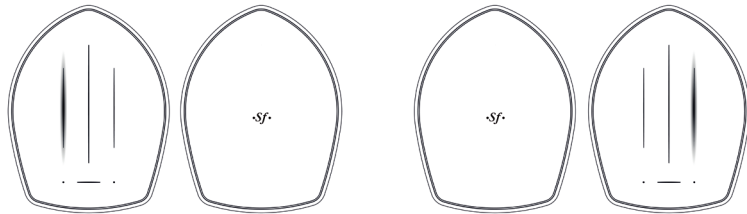

## 5.2

### Positionierung im Raum.

Empfohlene Raumgröße für optimalen Stereoklang: 20 m<sup>2</sup> bis 60 m<sup>2</sup>  
Empfohlene Mindestabstände für die Aufstellung der Lautsprecher: 2 m

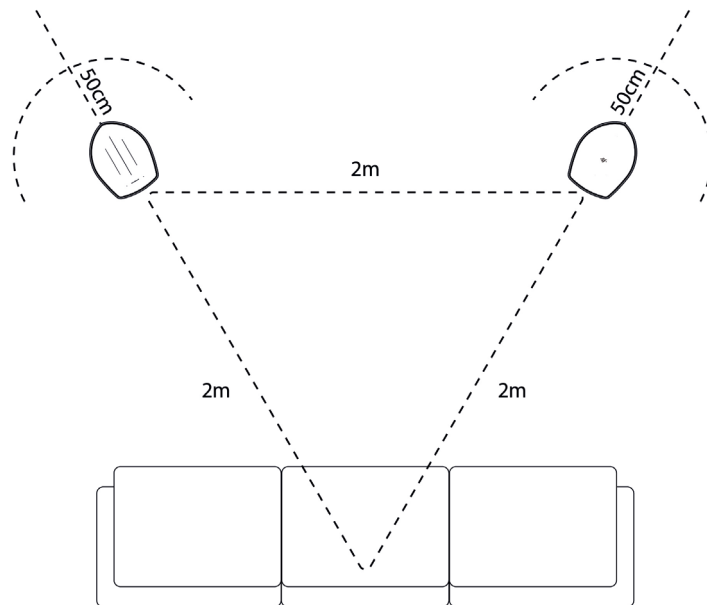

Nachdem der Duetto mit dem Wi-Fi-Netzwerk verbunden wurde, können die EQ-Parameter über die Konfigurationswebseite angepasst werden, um eine maximale Vielseitigkeit des Hörerlebnisses im Raum zu gewährleisten. (Kapitel 9).

Standardmäßig sind die Lautsprecher für die Verwendung im Abstand von den Wänden (50 cm) konfiguriert. Wenn die Lautsprecher nahe an der Wand positioniert sind, wählen Sie auf der Konfigurationswebseite die Option Room Placement „Near the wall“ (Raumplatzierung „nahe der Wand“).

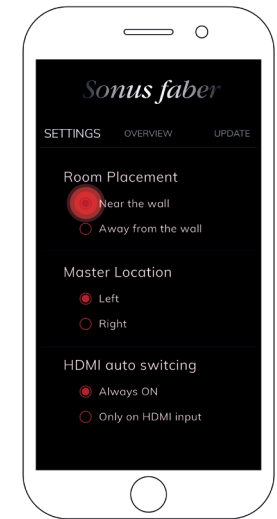

DE

# 6 WLAN-KONFIGURATION

Verbinden Sie Ihr Gerät mit demselben WLAN-Netzwerk, mit dem auch der Duetto verbunden ist.

Wenn die Steuerlinie weiß blinkt, sind die Lautsprecher bereit für die Konfiguration. Der Duetto unterstützt sowohl das 2,4-GHz- als auch das 5,2-GHz-WLAN-Band

## 6.1

### iOS-Geräte

#### Unter Verwendung der WLAN-Konfiguration

- Öffnen Sie die Einstellungen auf Ihrem iOS-Gerät
- WLAN-Einstellungen
- Wählen Sie Duetto-xxxx unter „Neuen Airplay-Lautsprecher einrichten“
- Wählen Sie Weiter und dann Fertig

#### Unter Verwenden der Home-App

- Installieren/aktualisieren Sie die Home-App
- Öffnen Sie die Home-App
- Wählen Sie Zubehör hinzufügen
- Folgen Sie dem Assistenten zur Konfiguration des WLANs

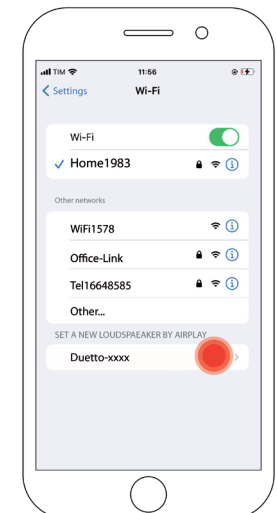

## 6.2

### Android™-Geräte

- Installieren/aktualisieren Sie die Google Home-App
- Öffnen Sie die Google Home-App
- Wählen Sie + oben links
- Wählen Sie Neues Gerät konfigurieren
- Folgen Sie dem Assistenten zur Konfiguration des WLANs

## 6.3

### Ethernet

- Verbinden Sie Ihren Router über ein Ethernet-Kabel mit dem Duetto

Weitere Einzelheiten und Informationen zur Fehlerbehebung finden Sie in der interaktiven Anleitung und im Installationsvideo unter [www.sonusfaber.com/en/products/Duetto/](http://www.sonusfaber.com/en/products/Duetto/)

# 7 MUSIKWIEDERGABE

## 7.1

### Streaming-App

Achten Sie darauf, dass die Farbe der Steuerlinie weiß ist. Falls nicht, gehen Sie zu Abschnitt 7.2  
Rufen Sie die gewünschte App auf und wählen Sie Duetto mit dem gewünschten Lautsprecher  
Das farbige Licht auf der Steuerlinie ändert sich nun je nach verwendetem Streaming-Dienst.

- AirPlay (weiß)
- Chromecast built-in (gelb)
- Spotify (grün)
- Tidal (hellblau/türkis)
- Roon (lila)

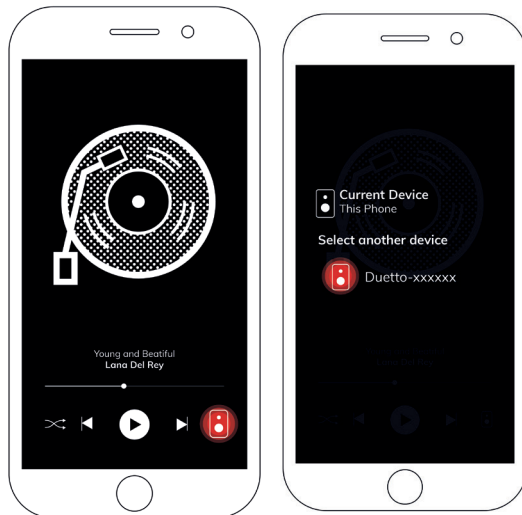

## 7.2

### Auswählen des Eingangs

Ändern Sie den Eingang, bis die Steuerlinie die gewünschte Farbe anzeigt.  
Streichen Sie von der Mitte nach rechts über die Steuerlinie, bis sie in der gewünschten Eingangsfarbe erscheint.  
Der Eingang kann auch mit der Fernbedienung gewechselt werden.

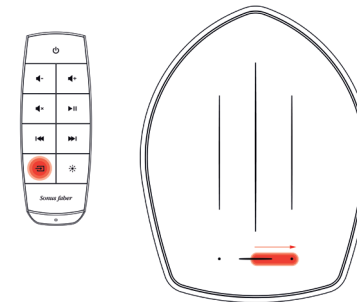

## 7.3

### Bluetooth

- Ändern Sie den Eingang, bis die Steuerlinie blau blinkt
- Wählen Sie in den Bluetooth-Einstellungen Ihres Geräts die Option Neues Gerät suchen
- Wählen Sie Duetto-xxxx in der Liste der verfügbaren Bluetooth-Geräte
- Wenn das blaue Licht auf der Steuerlinie aufhört zu blinken, ist der Duetto bereit für die Musikwiedergabe

## 7.4

### Physische Eingänge

Ändern Sie den Eingang, bis die Steuerlinie die gewünschte Farbe anzeigt:

- HDMI (Orange)
- Optical (Pink)
- Line/Phono (Magenta)

Stellen Sie sicher, dass das analoge Gerät korrekt konfiguriert ist.  
Geräteanforderungen::

- HDMI ARC: Auswahl der PCM/Stereo-TV-Signalkonfiguration
- Phono stage: Tonabnehmer (MM) mit Ausgangsspannungen von 2,4 mV bis 5,0 mV. Vergewissern Sie sich, dass Sie auf der Rückseite des Duetto in der Eingangskarte die Option „Phono“ ausgewählt haben. Der Line-Eingang ist für hochpegelige Signale wie z. B. CD-Player vorgesehen
- Optisch: Verwenden Sie die Option Optisch. Stellen Sie sicher, dass das Fernsehgerät auf ein digitales Audiosignal im PCM-Format konfiguriert ist

## 8 SUBWOOFER

Duetto bietet die Möglichkeit zur Einbindung eines externen Subwoofers in das System. Installieren Sie dazu ein Cinch-Kabel vom Subwoofer zu dem mit „Sub Out“ bezeichneten Eingang des Duetto Master. Der Subwoofer wird automatisch erkannt und dem System hinzugefügt. Zur optimalen Anpassung an den Raum stehen auf der Konfigurationswebseite Schieberegler für Verstärkung, Grenzfrequenz und Verzögerung zur Verfügung. (Kapitel 9).

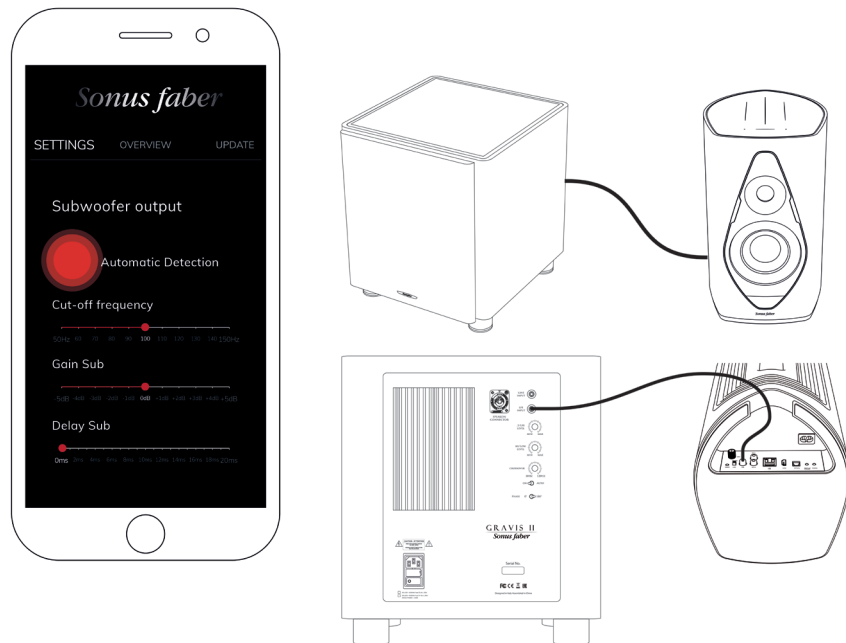

## 9 KONFIGURATIONSWEBSEITE

Für eine vollständig anpassbare Installation rufen Sie die Konfigurationswebseite auf. Mögliche Anpassungen: Name des Lautsprechers, Einschlaf-timer, Startlautstärkebegrenzung, Netzwerktyp, Entzerrungseinstellungen, Raumaufstellung, Master-Position, Subwoofer-Ausgang, automatische HDMI-Umschaltung

- Verbinden Sie sich mit dem WLAN-Netzwerk (Kapitel 6)
- Scannen Sie den QR-Code auf der Rückseite der Schnellstartanleitung



Der QR-Code darf erst gescannt werden, nachdem der Duetto mit dem WLAN-Netzwerk verbunden wurde  
Scannen Sie ihn nicht, wenn kein WLAN-Netzwerk verfügbar ist  
Alternativ können Sie auch die Adresse unter dem QR-Code in Ihren Browser eingeben.

## 1 CONTENIDO DEL EMBALAJE

### 1.1

Registra Duetto en [sonusfaber.com](https://sonusfaber.com) y obtén 1 año adicional de garantía!

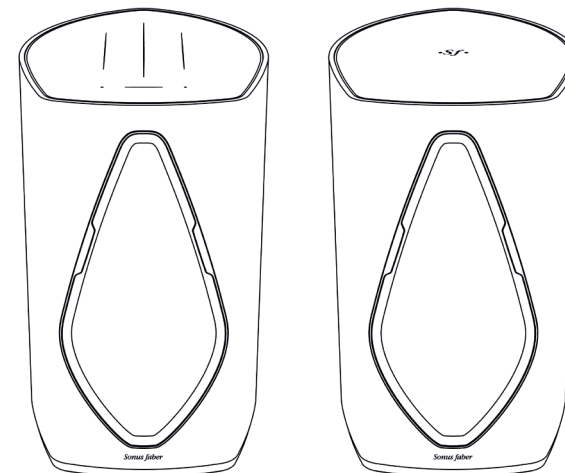

Altavoces con rejas de tela desmontables

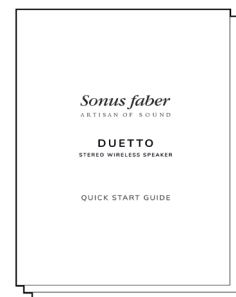

Guía de instalación

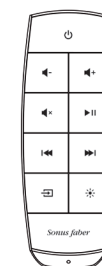

Mando a distancia



Cubiertas de protección



Cable de alimentación



## 2 CONTROLES

### 2.1 Altavoz

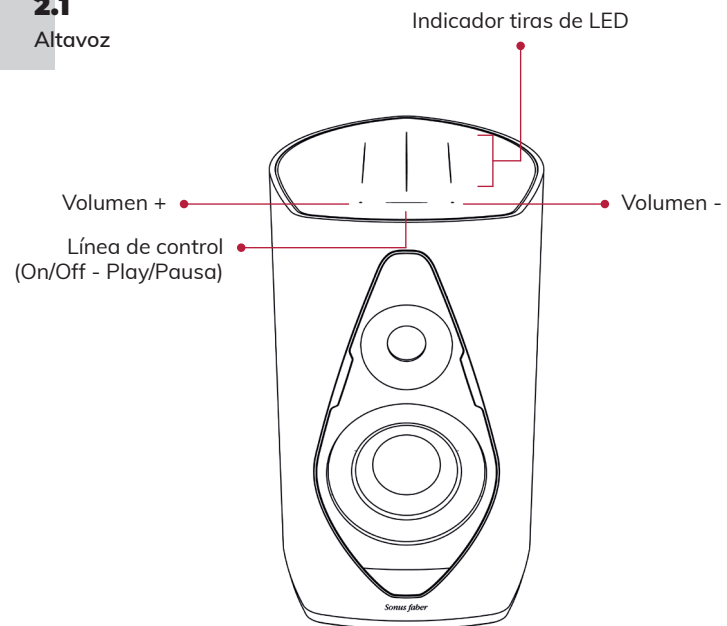

### 2.2 Mando a distancia

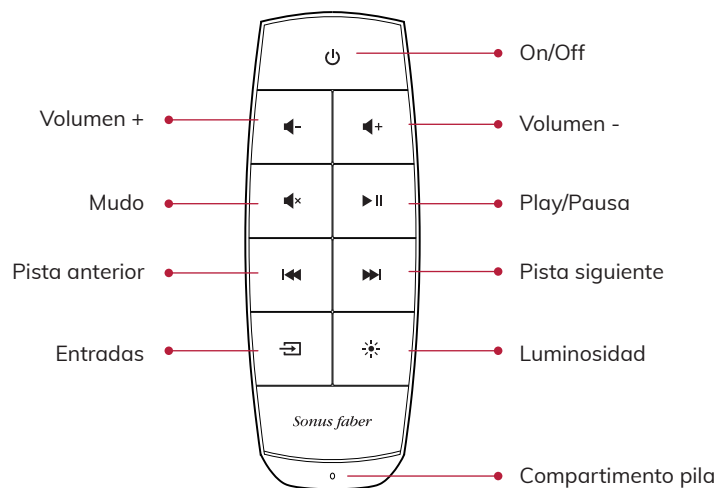

## 3 ENTRADAS

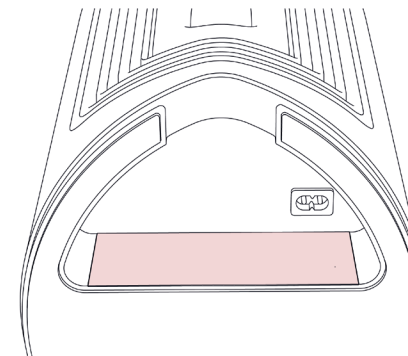

### 3.1 Altavoz Master

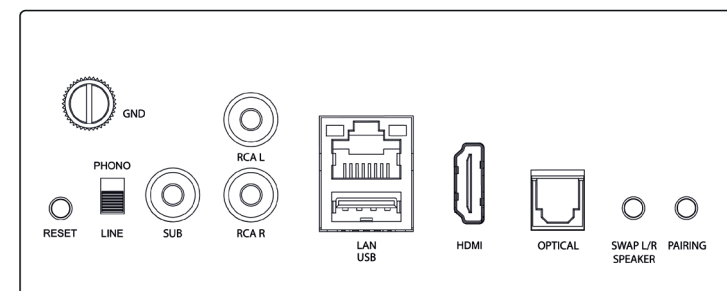

### 3.2 Altavoz Satellite

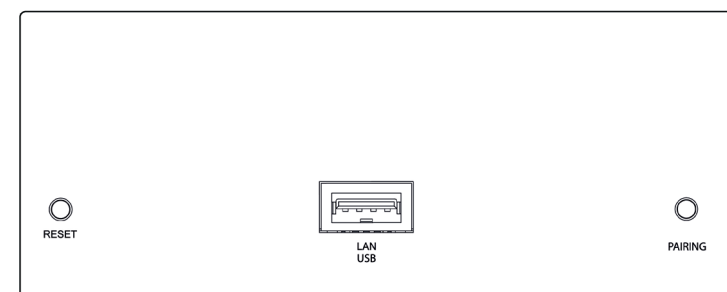



# 4 EMPIEZA

## 4.1

Coloca el Duetto Master y el Satellite en el lugar en que deseas utilizarlos y conecta el cable de alimentación.

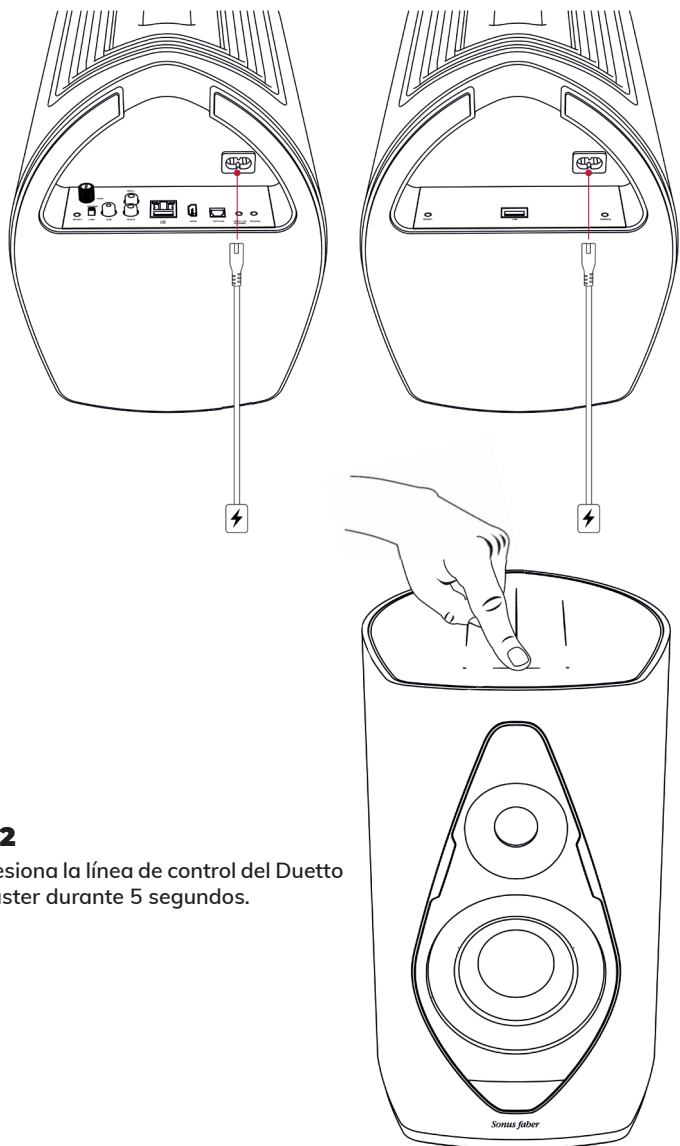

## 4.2

Presiona la línea de control del Duetto Master durante 5 segundos.

## 4.3

Empareja el Master y el Satellite.

Presiona el botón "Pairing" en la parte posterior de un altavoz. Antes de que transcurran 30 s, presiona el botón "Pairing" en la parte posterior del otro altavoz

Altavoz Master

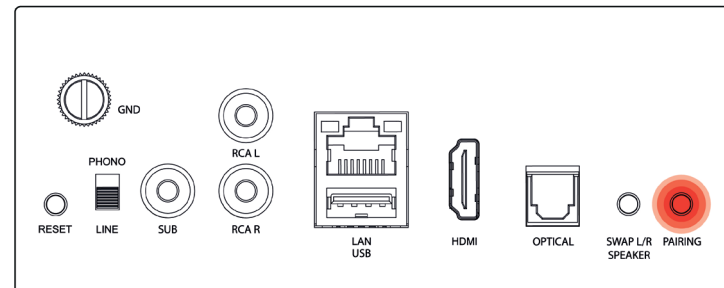

Altavoz Satellite

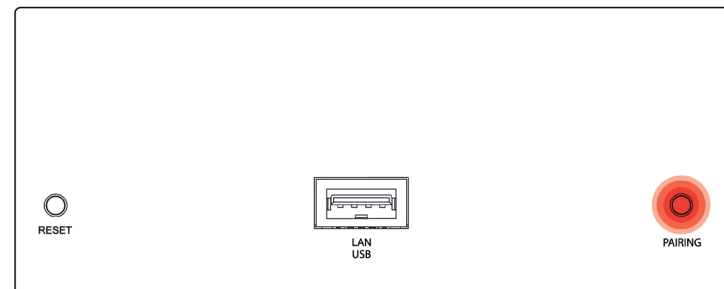

Una animación luminosa indica que el emparejamiento se ha realizado correctamente

# 5 COLOCACIÓN

## 5.1

Colocación a la derecha o a la izquierda.

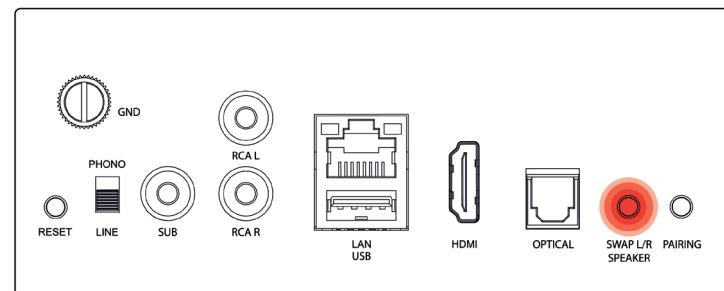

ES

De forma predeterminada, el altavoz Master está configurado para ser el altavoz izquierdo. Para usarlo como altavoz derecho, debes presionar el botón "SWAP L/R SPEAKER" en la tarjeta de entrada en la parte posterior del Duetto maestro. Una animación luminosa indica que la posición se ha invertido correctamente.

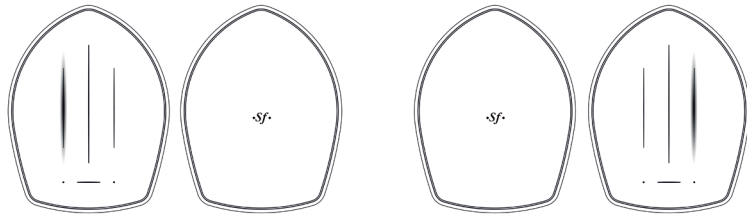

## 5.2

### Colocación en la habitación.

Tamaño de habitación recomendado para una óptima escucha estéreo: de 20 m<sup>2</sup> a 60 m<sup>2</sup>  
Distancias mínimas recomendadas para colocar los altavoces: 2 m

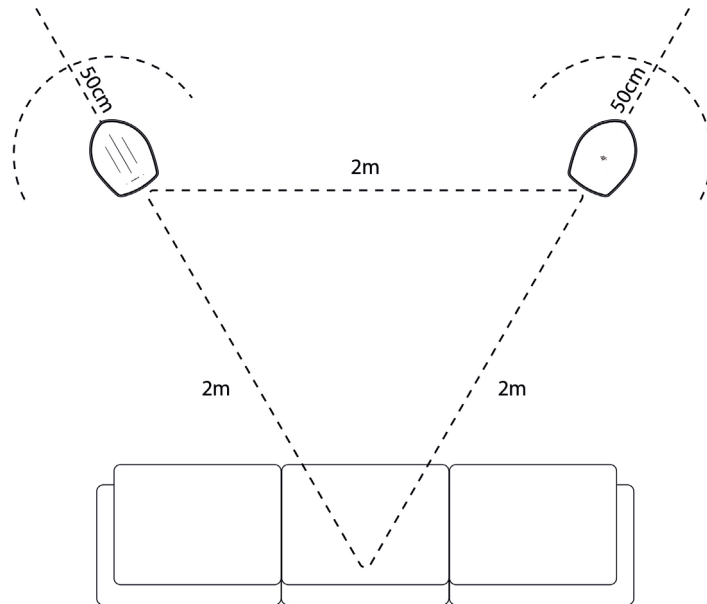

Después de conectar Duetto a la red wifi, para garantizar la máxima versatilidad de escucha en la sala, puedes cambiar los parámetros de EQ en la página web de configuración. (Capítulo 9)

De forma predeterminada, los altavoces están configurados para usarse distanciados de la pared (50 cm). Si los altavoces se colocan cerca de la pared, selecciona "Near the wall" en "Room Placement" de la página web de configuración.

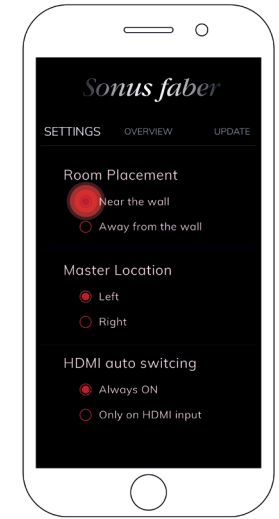

## 6 CONFIGURACIÓN WIFI

Conecta tu dispositivo a la misma red wifi a la que está conectado Duetto. Cuando la línea de control parpadea de color blanco, los altavoces están listos para configurarse. Duetto es compatible con las bandas wifi de 2,4 GHz y 5,2 GHz.

### 6.1

#### Dispositivos iOS

##### Utilizando los ajustes de la wifi

- Abre Ajustes en el dispositivo IOS
- Ve al menú Wi-Fi
- Selecciona Duetto-xxxxx en Configurar un nuevo altavoz AirPlay
- Selecciona Siguiete y, luego, Hecho

##### Utilizando la app Casa

- Instala/Actualiza la app Casa
- Abre la app Casa
- Selecciona Añadir accesorio
- Sigue el asistente para configurar la wifi

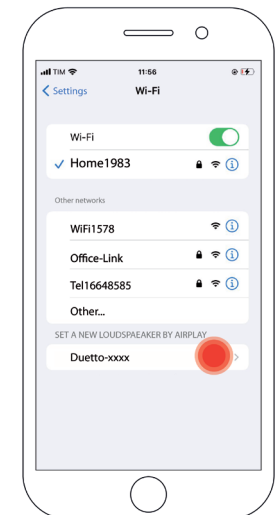

## 6.2

### Dispositivos Android™

- Instala/Actualiza la app Google Home
- Abre la app Google Home
- Selecciona + arriba a la izquierda
- Selecciona Configurar nuevo dispositivo
- Sigue el asistente para configurar la wifi

## 6.3

### Ethernet

- Conecta el enrutador a Duetto con un cable Ethernet

Para más información y solucionar problemas, consulta el manual interactivo y el vídeo de instalación en [www.sonusfaber.com/en/products/Duetto/](http://www.sonusfaber.com/en/products/Duetto/)

# 7 REPRODUCIR MÚSICA

## 7.1

### App de streaming

Asegúrate de que el color de la línea de control sea blanco. En caso contrario, ve a la sección 7.2

Accede a la app deseada y elige Duetto con el altavoz deseado.

El color de la línea de control cambiará según el servicio de streaming utilizado.

- AirPlay (blanco)
- Chromecast built-in (amarillo)
- Spotify (verde)
- Tidal (celeste/turquesa)
- Roon (violeta)

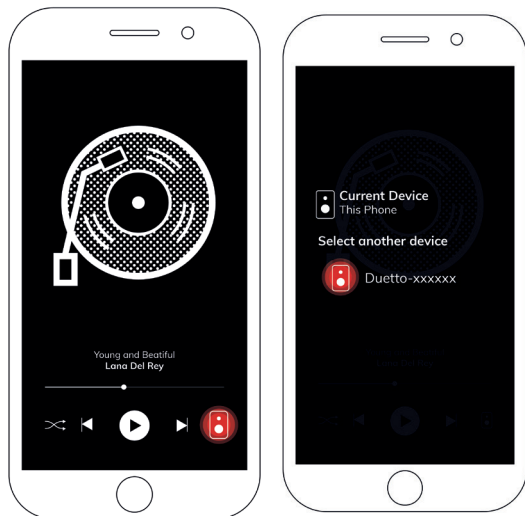

## 7.2

### Selección de la entrada

Cambia la entrada hasta que la línea de control sea del color de la entrada deseada. Muévete desde el centro de la línea de control hacia la derecha hasta que aparezca el color de la entrada deseada.

La entrada puede cambiarse en modo remoto con el mando a distancia.

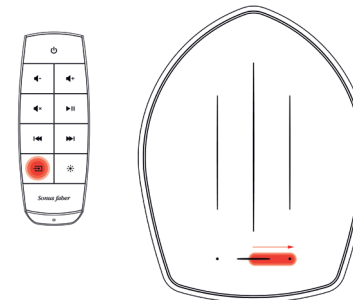

## 7.3

### Bluetooth

- Cambia la entrada hasta que la línea de control comience a parpadear en azul
- En los ajustes de Bluetooth del dispositivo, selecciona Buscar nuevo dispositivo
- Selecciona Duetto-xxxxxx en la lista de dispositivos Bluetooth disponibles
- Cuando la luz azul de la línea de control deje de parpadear, el Duetto estará listo para reproducir música

## 7.4

### Entradas físicas

Cambia la entrada hasta que la línea de control sea del color de la entrada deseada:

- HDMI (naranja)
- Optical (fucsia)
- Line/Phono (magenta)

Asegúrate de que el dispositivo analógico esté configurado correctamente.

Requisitos de los dispositivos::

- HDMI ARC: selecciona la configuración de la señal TV PCM/Stereo
- Phono stage: cartuchos (MM) phono con salida de 2,4 mV a 5,0 mV. Asegúrate de seleccionar Phono en la tarjeta de entrada en la parte posterior de Duetto. Line In está dedicada a las señales de alto nivel, como reproductores de CD
- Optical: utiliza la opción Optical. Asegúrate de que tu televisor esté configurado en una señal de audio digital en formato PCM

## 8 SUBWOOFER

Duetto permite añadir un subwoofer externo al sistema. Para ello, conecta un cable RCA desde el subwoofer hasta la entrada del Duetto maestro identificada como "Sub Out". El subwoofer se detectará automáticamente y se añadirá al sistema. Para adaptarlo mejor a la habitación, las opciones de ajuste de Gain, Cut-off frequency y Delay sliders están presentes en la página web de configuración. (Capítulo 9).

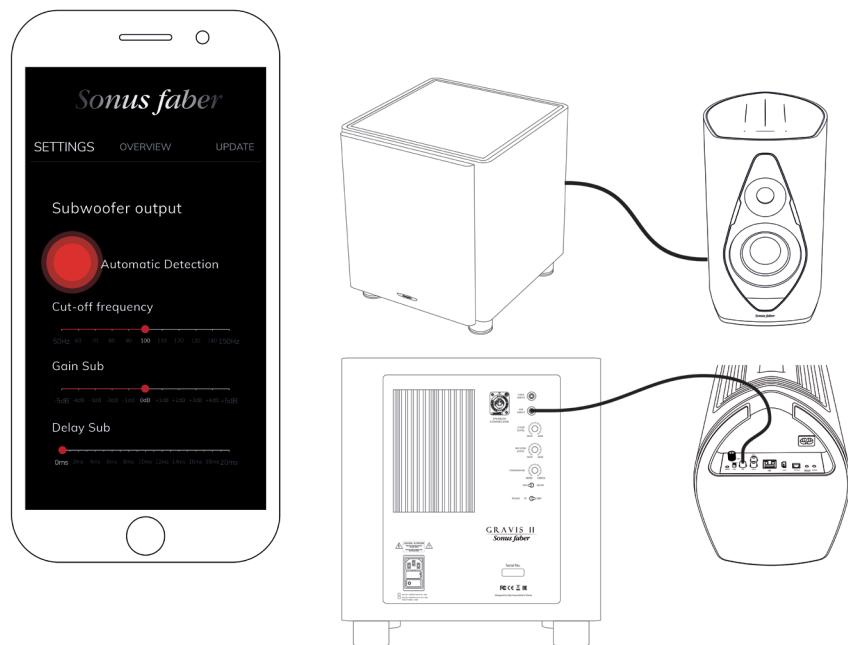

## 9 PÁGINA WEB DE CONFIGURACIÓN

Para personalizar completamente el sistema, accede a la página web de configuración. Personalizaciones disponibles: Speaker name, Power Sleep Timer, Startup Volume Limit, Network Type, Equalization Settings, Room Placement, Master Location, Subwoofer output y HDMI Auto Switching.

- Conéctate a la red wifi (capítulo 6)
- Escanea el código QR presente en la parte posterior de la Guía de inicio rápido



El código QR solo se debe escanear después de conectar el Duetto a la red wifi. No lo escanees si la red wifi no está disponible. Como alternativa, escribe en tu navegador la dirección indicada debajo del código QR.

## 1 CONTEÚDO DA EMBALAGEM

### 1.1

Registe Duetto em [sonusfaber.com](https://sonusfaber.com) para obter uma cobertura adicional de 1 ano de garantia!

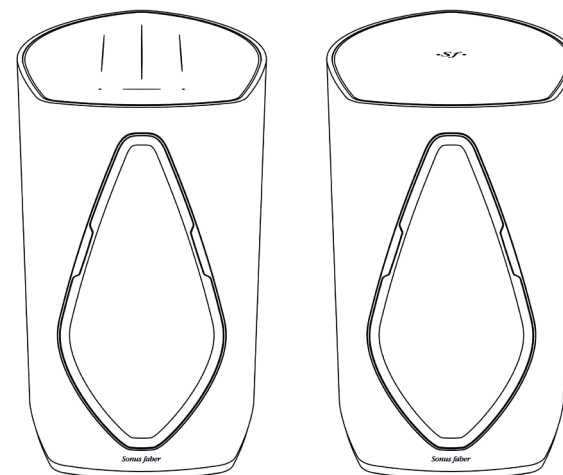

Speakers com máscaras de tecido removíveis

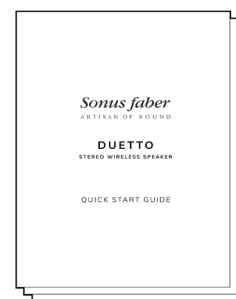

Guia de instalação

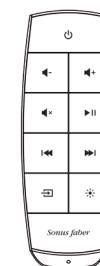

Controlo remoto



Cobertura de proteção



Cabos de alimentação

## 2 CONTROLOS

### 2.1 Speaker

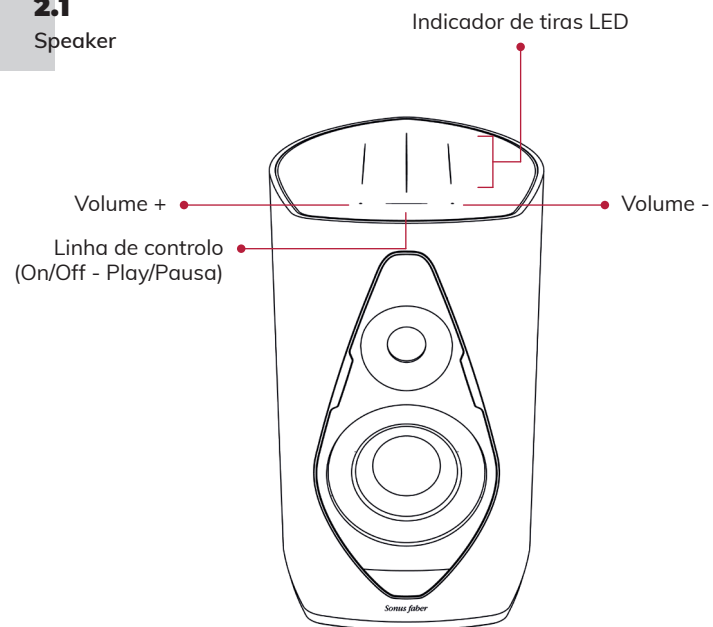

### 2.2 Controlo remoto

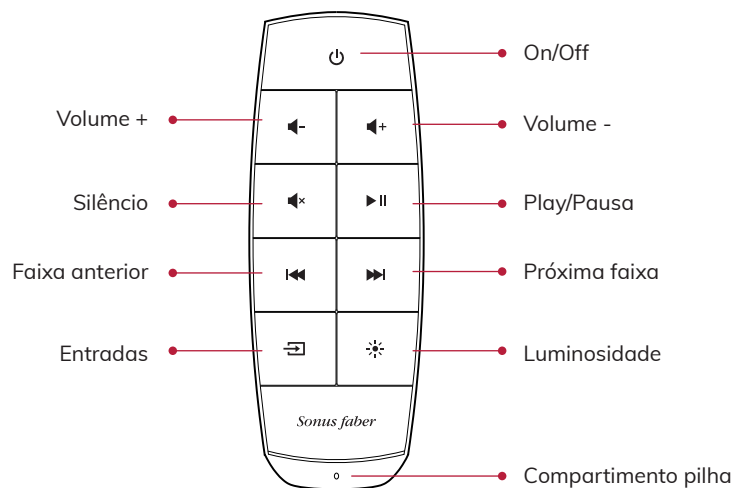

## 3 INPUTS

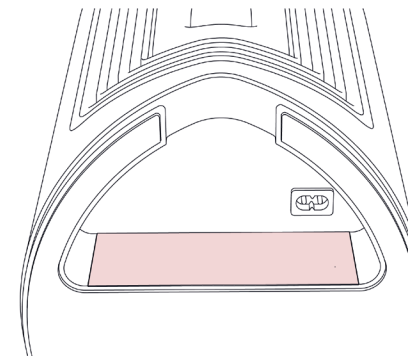

### 3.1 Speaker mestre

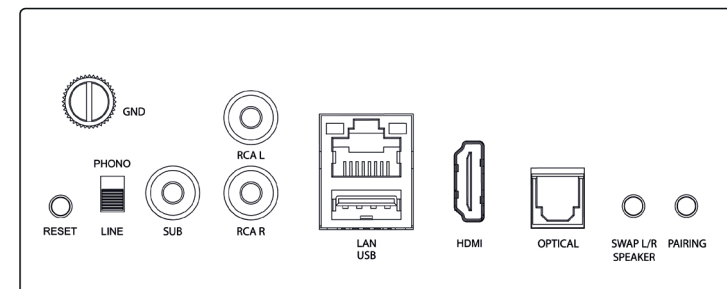

### 3.2 Speaker secundário

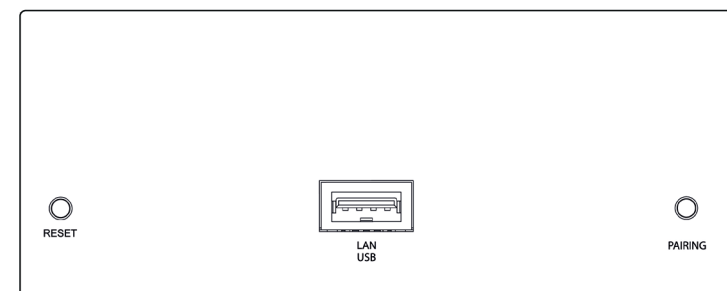

## 4 INICIAR

### 4.1

Coloque Duetto Master e Satellite onde pretende usá-los e, em seguida, conecte o cabo de alimentação.

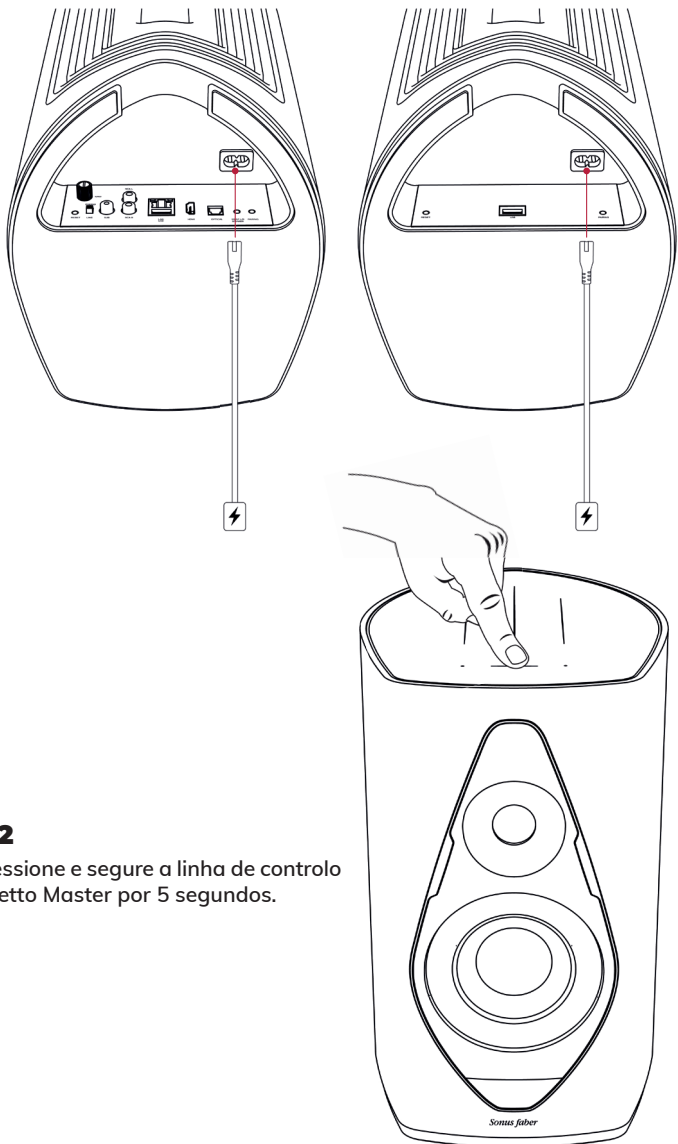

### 4.2

Pressione e segure a linha de controlo Duetto Master por 5 segundos.

## 4.3

Emparelhar Master e secundário.

Pressionar o botão "Pairing" na parte de trás de um dos speaker. Dentro de 30 segundos, pressione o botão "Pairing" na parte de trás do outro speaker.

Speaker Master

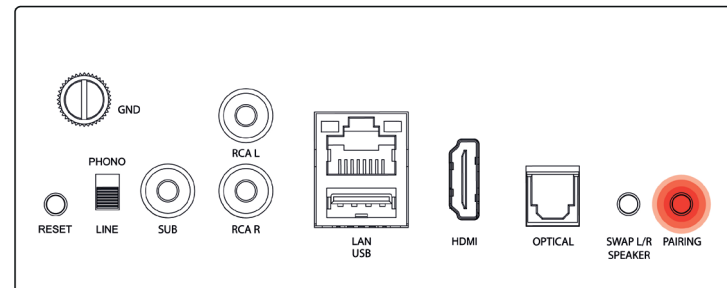

Speaker Satellite

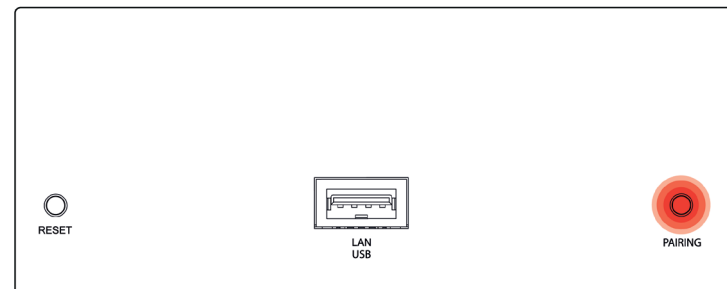

Uma animação luminosa indicará o emparelhamento bem-sucedido.

## 5 POSICIONAMENTO

### 5.1

Posicionamento à direita e esquerda.

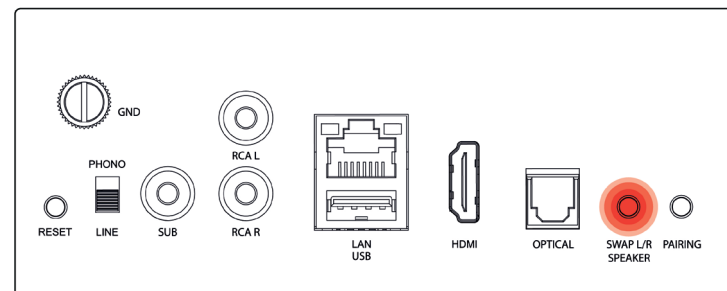

Por padrão, a unidade Master é configurada para ser o speaker esquerdo. Para usá-lo como um speaker direito, é necessário pressionar o botão "SWAP L/R SPEAKER" na placa de entrada na parte de trás do Duetto mestre. Uma animação luminosa indicará a inversão de posicionamento..

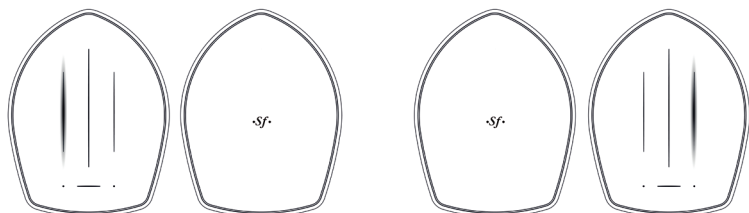

## 5.2

### Posicionamento na sala.

Dimensão da sala recomendada para audição estéreo ideal: de 20m<sup>2</sup> a 60m<sup>2</sup>  
Distâncias mínimas recomendadas para o posicionamento do speaker: 2m

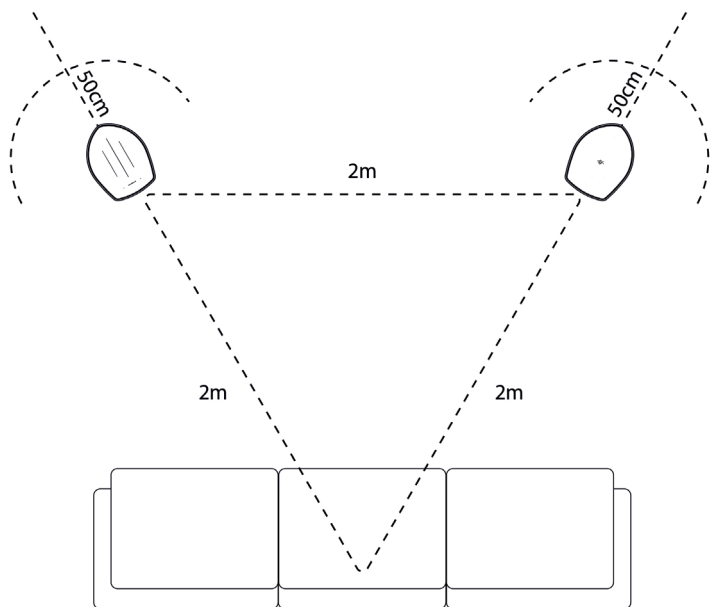

Depois de conectar o Duetto à rede Wi-Fi, para garantir a máxima versatilidade de audição dentro da sala, os parâmetros EQ podem ser adaptados através da página de configuração. (Capítulo 9)

Por padrão, os speaker são configurados para serem usados remotamente nas paredes (50cm). Se os speaker estiverem posicionados perto das paredes, selecione Room Placement "Near the wall" na página da web de configuração.

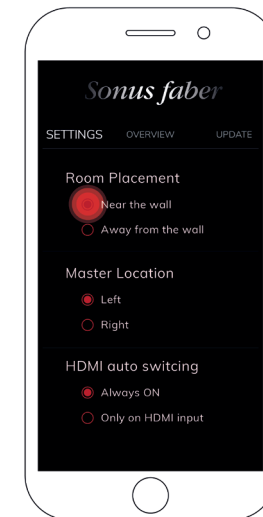

## 6 CONFIGURAÇÃO WI-FI

Conecte o dispositivo à mesma rede Wi-Fi à qual o Duetto está conectado. Quando a Linha de controlo piscar em branco, os speaker estarão prontos para serem configurados. Duetto suporta ambas as bandas Wi-Fi de 2,4Ghz e 5,2 Ghz.

### 6.1

#### Dispositivos iOS

##### Utilizar a configuração Wi-Fi

- Abra as Configurações no seu dispositivo iOS
- Configuração Wi- Fi
- Selecione Duet-xxxxxx dentro de Configurar um novo speaker AirPlay
- Selecione Seguinte e, em seguida, Concluído

##### Utilização da app Home

- Instalar/Atualizar a App Home
- Abrir a App Home
- Selecionar Adicionar Acessório
- Siga o assistente para configurar o Wi-Fi

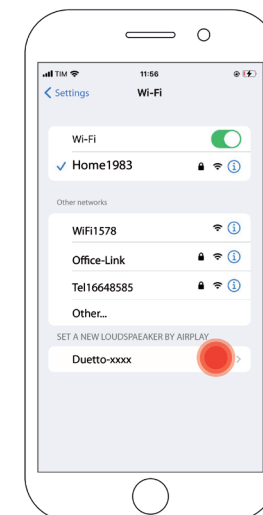

## 6.2

### Dispositivos Android™

- Instalar/Atualizar a App Google Home
- Abra a App Google Home
- Selecionar + em cima à esquerda
- Selecionar Configurar novo dispositivo
- Siga o assistente para configurar o Wi-Fi

## 6.3

### Ethernet

- Ligue o seu router Duetto através de um cabo Ethernet

Para mais detalhes e resolução de problemas, consulte o manual interativo e o vídeo de instalação em [www.sonusfaber.com/en/products/Duetto/](http://www.sonusfaber.com/en/products/Duetto/)

# 7 REPRODUZIR A MÚSICA

## 7.1

### App de streaming

Certifique-se de que a cor da linha de controlo é branca. Caso contrário, consulte a secção 7.2.

Aceda à App pretendida e escolha Duetto com o speaker pretendido.

A luz colorida da Linha de controlo agora mudará dependendo do serviço de streaming usado.

- AirPlay (branco)
- Chromecast built-in (amarelo)
- Spotify (verde)
- Tidal (azul escuro/turquesa)
- Roon (roxo)

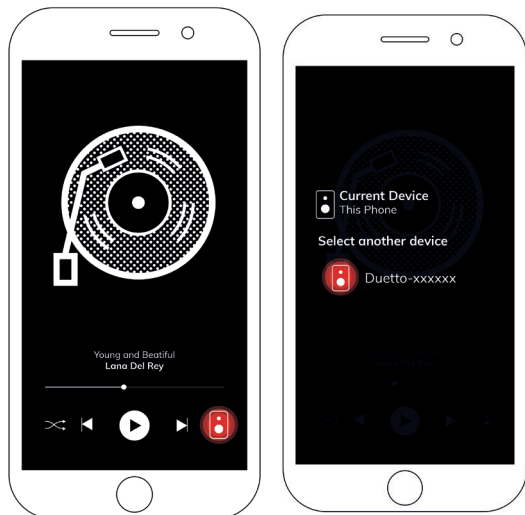

## 7.2

### Selecionar o input

Altere o input até que a Linha de controlo indique a cor da entrada desejada. Deslize do centro para a direita da Linha de controlo até aparecer a cor do input desejado. O input também pode ser alterado remotamente usando o controlo remoto.

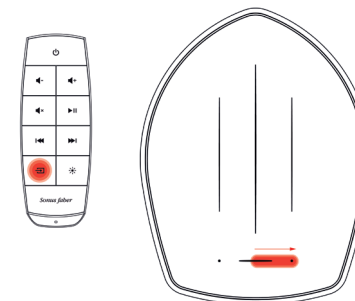

## 7.3

### Bluetooth

- Altere o input até que a linha de controlo comece a piscar em azul
- Dentro das definições Bluetooth do seu dispositivo, selecione a pesquisa de um novo dispositivo
- Selecione Duetto-xxxxxx na lista de dispositivos Bluetooth disponíveis
- Quando a luz azul da linha de controlo parar de piscar, o Duetto estará pronto para reproduzir a música

## 7.4

### Entradas físicas

Altere o input até que a Linha de controlo indique a cor da entrada desejada:

- HDMI (laranja)
- Optical (fúcsia)
- Line/Phono (mangenta)

Certifique-se de que o dispositivo analógico esteja configurado corretamente. Necessidade dos dispositivos::

- HDMI ARC: selecione a configuração do sinal TV PCM/Estéreo
- Phono stage: Cabeças (MM) phono com saída de 2,4mV até 5,0mV. Certifique-se de que selecciona Phono na placa de entrada na traseira de Duetto. Line In é dedicado a sinais de alto nível, como os reprodutores de CD
- Optical: utilize a opção Optical. Certifique-se se a TV está configurada num sinal de áudio digital no formato PCM



## 8 SUBWOOFER

Duetto dá a possibilidade de adicionar um subwoofer externo ao sistema. Para isso, conecte um cabo RCA do subwoofer ao input de Duetto mestre chamado "Sub Out". O subwoofer será automaticamente detetado e adicionado ao sistema. Para melhor adaptá-lo à sala, as opções de regulação de gain, cut-off frequency e delay sliders estão presentes na página web de configuração. (Capítulo 9)

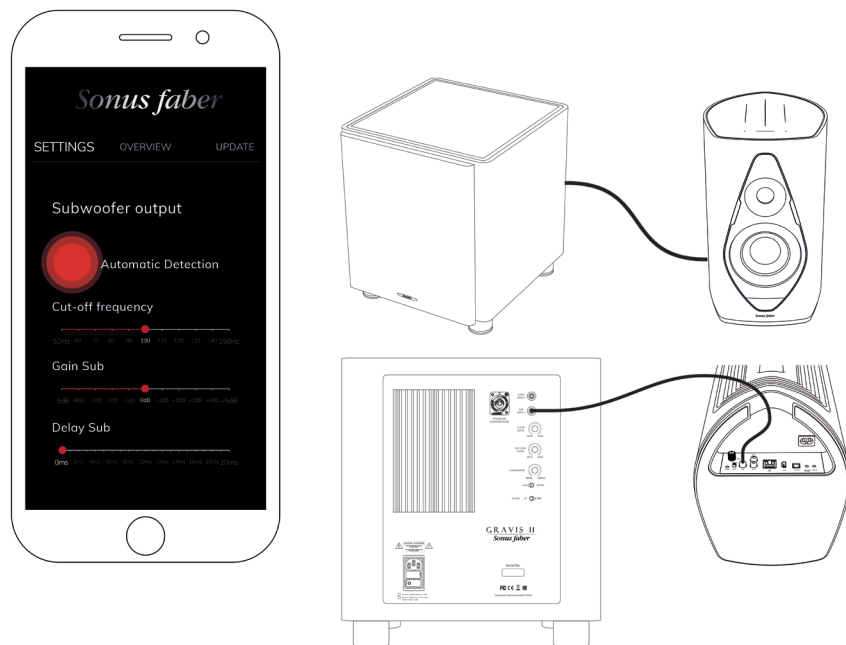

## 9 PÁGINA WEB DE CONFIGURAÇÃO

Para uma instalação totalmente personalizável, vá para a página web de configuração. Personalizações disponíveis: Nome do Speaker, Power Sleep Timer, Startup Volume Limit, Network Type, Equalization Settings, Room Placement, Master Location, Subwoofer output, HDMI Auto Switching.

- Conectar-se à rede Wi-Fi (Capítulo 6)
- Digitalize o código QR na parte de trás do Guia de Início Rápido



O código QR só deve ser digitalizado depois de conectar o Duetto à rede Wi-Fi. Não digitalizar se a rede Wi-Fi não estiver disponível. Se preferir, insira o endereço abaixo do código QR no seu navegador.

## 1 INHOUD VAN DE VERPAKKING

### 1.1

Registreer Duetto op [sonusfaber.com](https://sonusfaber.com) om een extra garantiedekking van 1 jaar te verkrijgen!

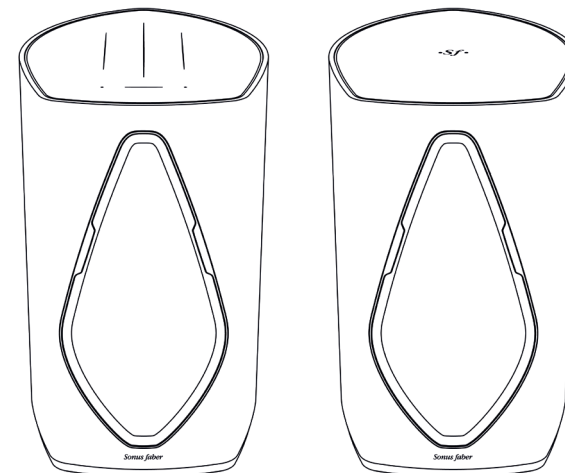

Speakers met verwijderbare speakerdoeken

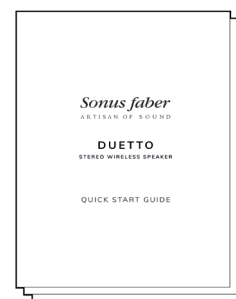

Installatiegids

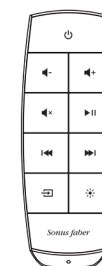

Afstandsbediening



Beschermende afdekkingen



Beschermende afdekkingen

## 2 BEDIENINGSELEMENTEN

### 2.1 Speaker

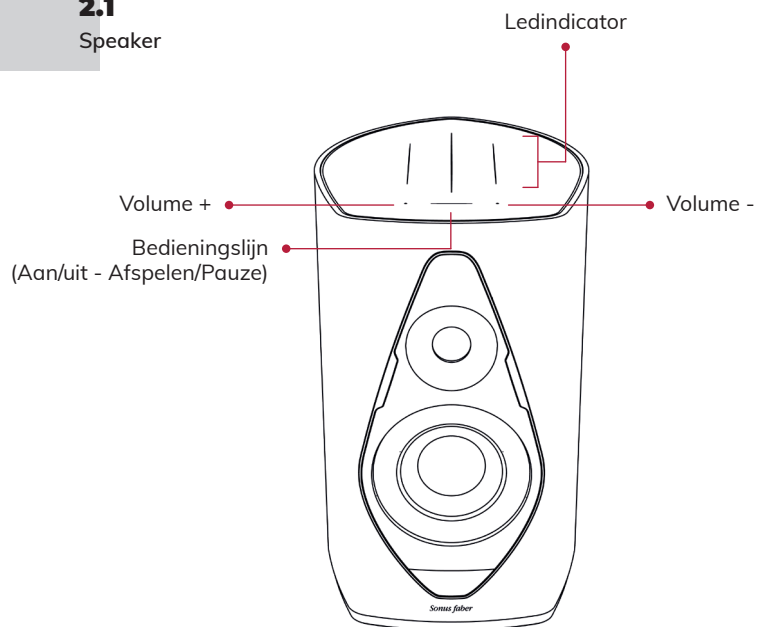

### 2.2 Afstandsbediening

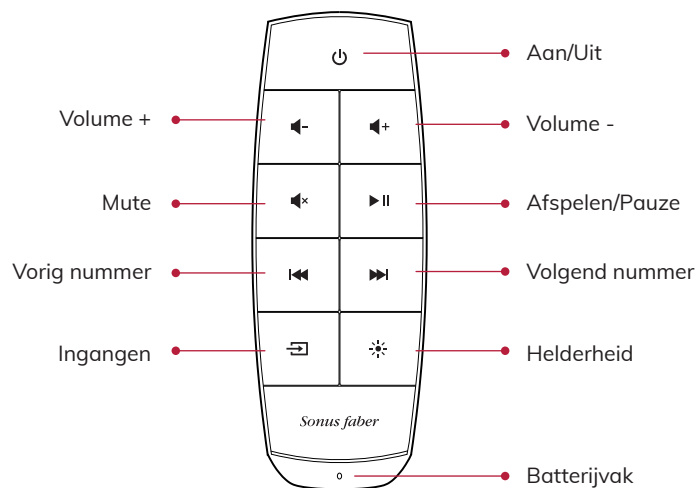

## 3 INGANGEN

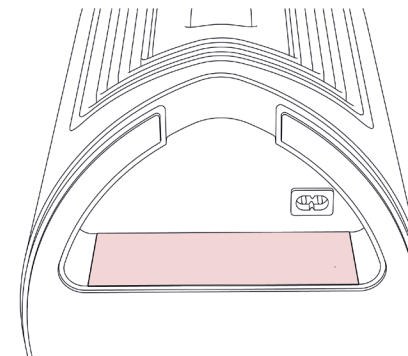

### 3.1 Masterspeaker

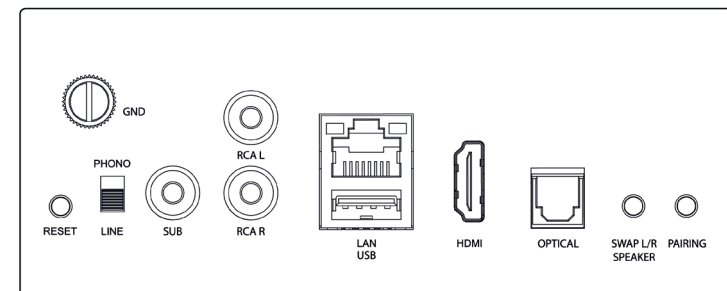

### 3.2 Satellietspeaker

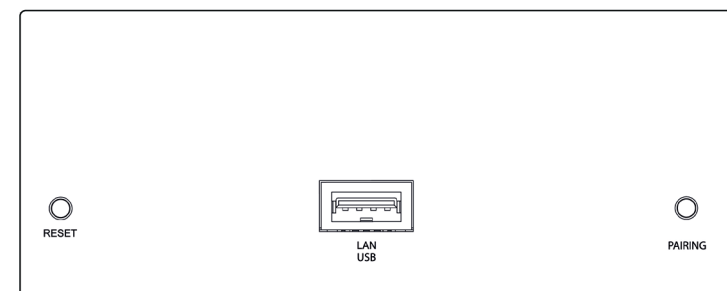

## 4 STARTEN

### 4.1

Breng een masterspeaker en een satellietspeaker van Duetto in positie op de plaats waar u ze wilt gebruiken en sluit daarna de voedingskabel aan.

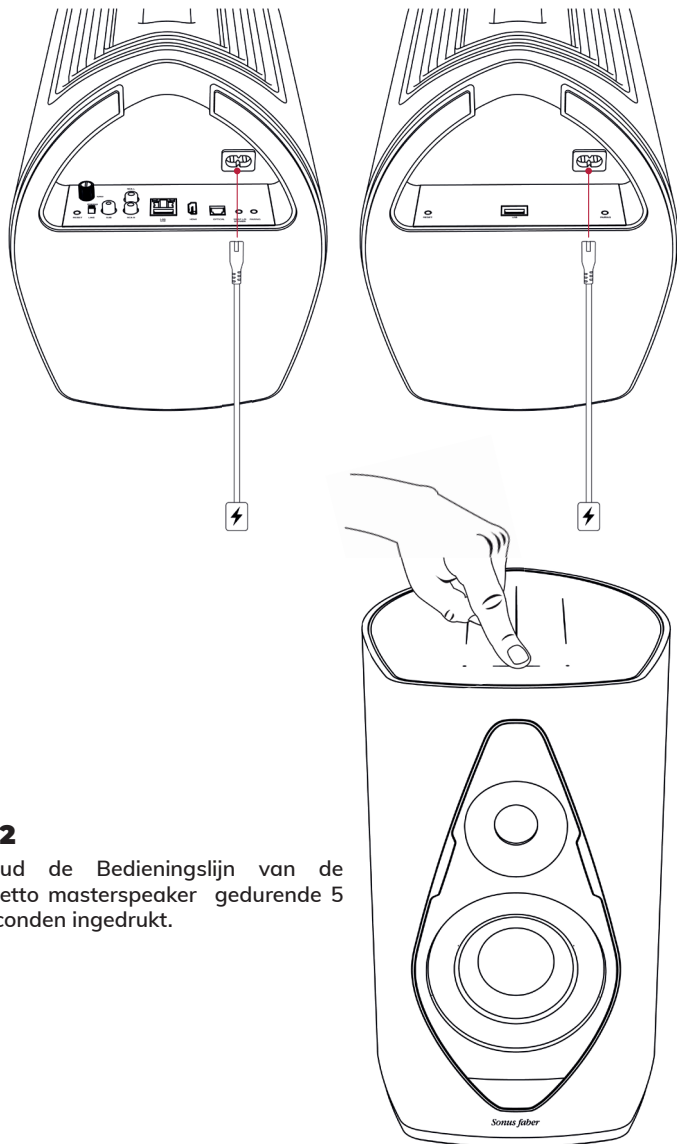

### 4.2

Houd de Bedieningslijn van de Duetto masterspeaker gedurende 5 seconden ingedrukt.

### 4.3

Masterspeaker en satellietspeaker koppelen.

Druk op de achterkant van een speaker op de knop "Pairing". Druk binnen 30 seconden op de achterkant van de andere speaker op de knop "Pairing".

Masterspeaker

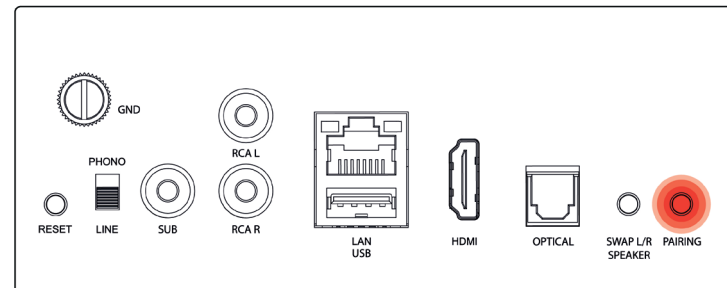

Satellietspeaker

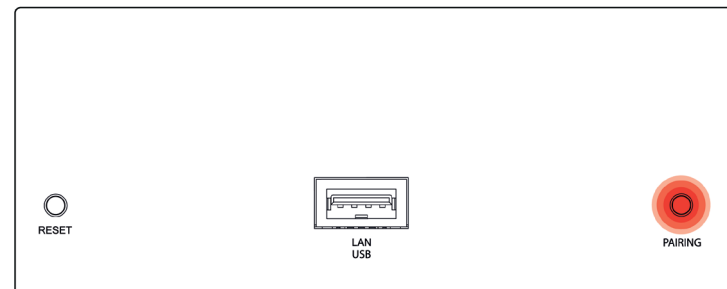

Een verlichte animatie zal aangeven dat de koppeling plaatsgevonden heeft.

## 5 POSITIONERING

### 5.1

Positionering rechts en links

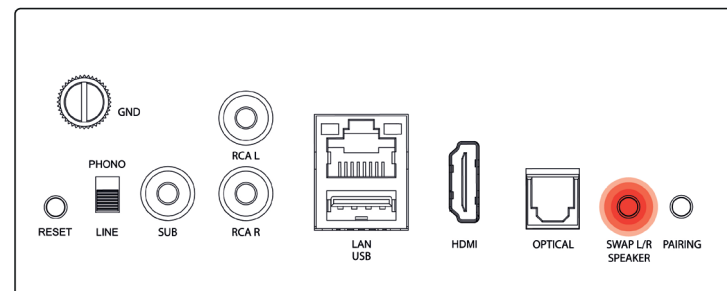

Als standaardinstelling is de masterspeaker ingesteld om de linker speaker te zijn. Om hem als rechter speaker te gebruiken, is het noodzakelijk op de knop "SWAP L/R SPEAKER" te drukken op de ingangskaat op de achterkant van de Duetto masterspeaker. Een verlichte animatie zal aangeven dat de positionering omgekeerd is..

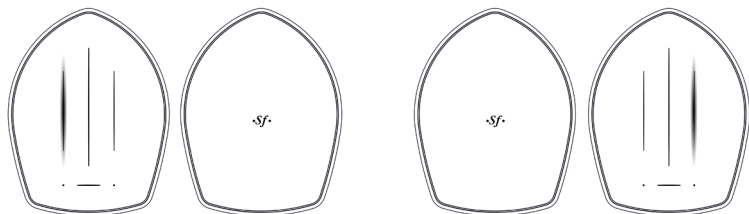

## 5.2

### Positionering in de kamer.

Aanbevolen afmetingen van de kamer voor optimaal stereo luisteren: van 20m<sup>2</sup> tot 60m<sup>2</sup>  
 Aanbevolen minimumafstanden voor de positionering van de speakers: 2 m

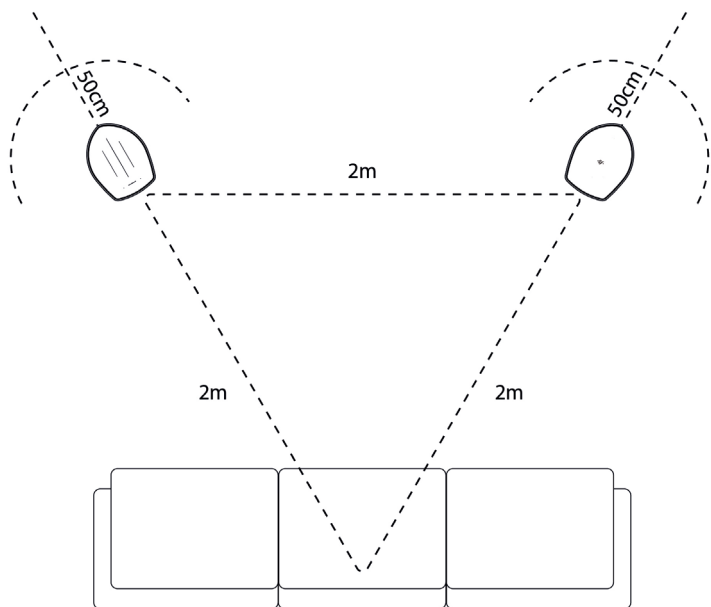

Nadat Duetto op het wifi-netwerk aangesloten is, kunnen de EQ-parameters, die maximale veelzijdigheid bij het luisteren garanderen, aangepast worden via de webpagina voor de set-up. (Hoofdstuk 9)

Als standaardinstelling zijn de speakers ingesteld om gebruikt te worden op afstand (50 cm) van de muren. Als de speakers dichtbij de muur opgesteld zijn, selecteer dan Room Placement "Near the wall" op de webpagina voor de set-up.

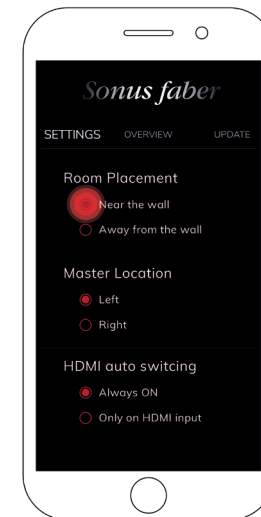

## 6 WIFI SET-UP

Sluit het eigen apparaat aan op hetzelfde wifi-netwerk waarop Duetto aangesloten is. Als de Bedieningslijn wit knippert, zijn de speakers gereed om ingesteld te worden. Duetto ondersteunt de beide wifi-banden 2.4Ghz en 5.2Ghz.

### 6.1

#### iOS-apparaten

##### Bij gebruik van wifi set-up

- Open de instellingen op het eigen iOS-apparaat
- Wifi-instellingen
- Selecteer Duetto-xxxxxx in Set-up van een nieuwe AirPlay speaker
- Selecteer Volgende en daarna Gedaan

##### Bij gebruik van de Home app

- Installeer/Update de Home app
- Open de Home app
- Selecteer Accessoires Toevoegen
- Volg de wizard om de wifi in te stellen

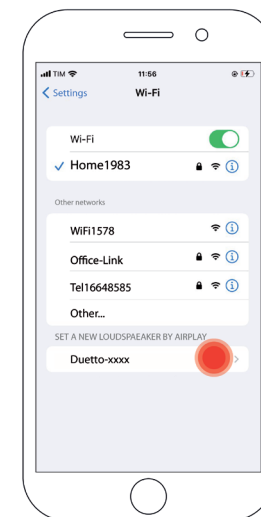

## 6.2

### Android™ -apparaten

- Installeer/Update de Google Home app
- Open de Google Home app
- Selecteer + linksboven
- Selecteer Set-up nieuw apparaat
- Volg de wizard om de wifi in te stellen

## 6.3

### Ethernet

- Verbind de eigen router met Duetto via een Ethernetkabel

Raadpleeg voor meer details en het oplossen van problemen de interactieve handleiding en de installatievideo op [www.sonusfaber.com/en/products/Duetto/](http://www.sonusfaber.com/en/products/Duetto/)

# 7 MUZIEK AF SPELEN

## 7.1

### App di streaming

Controleer of de kleur van de bedieningslijn wit is. Is dat niet het geval, ga dan naar paragraaf 7.2.

Ga naar de gewenste app en kies Duetto met gewenste speaker.

Het gekleurde licht van de Bedieningslijn zal nu veranderen op grond van de gebruikte streamingdienst.

- AirPlay (wit)
- Chromecast built-in (geel)
- Spotify (groen)
- Tidal (lichtblauw/turkoois)
- Roon (paars)

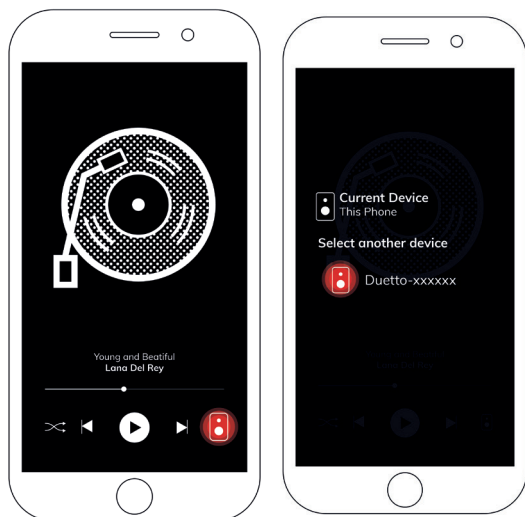

## 7.2

### De ingang selecteren

Wijzig de ingang tot de Bedieningslijn de kleur van de gewenste ingang aangeeft. Scroll de Bedieningslijn van het midden naar rechts, tot de kleur van de gewenste ingang verschijnt.

De ingang kan ook op afstand gewijzigd worden met gebruik van de afstandsbediening.

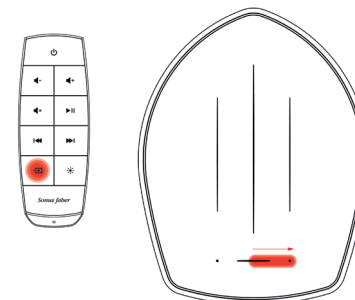

## 7.3

### Bluetooth

- Wijzig de ingang tot de Bedieningslijn blauw begint te knipperen
- Selecteer in de Bluetooth-instellingen van het eigen apparaat het zoeken naar een nieuw apparaat
- Selecteer Duetto-xxxxxx in de lijst met beschikbare Bluetooth-apparaten
- Wanneer het blauwe licht van de Bedieningslijn ophoudt met knipperen, zal de Duetto klaar zijn om muziek af te spelen

## 7.4

### Analoge Ingangen

Wijzig de ingang tot de Bedieningslijn de kleur van de gewenste ingang aangeeft:

- HDMI (oranje)
- Optical (fuchsia)
- Line/Phono (magenta)

Controleer of het analoge apparaat correct ingesteld is. Vereisten voor de apparaten::

- HDMI ARC: selecteer de set-up van het TV PCM/Stereo signaal
- Phono stage: Phono-koppen (MM) met uitgangen van 2.4mV tot 5.0mV. Controleer of Phono geselecteerd is op de ingangkaart op de achterkant van Duetto. Line In is bestemd voor het signaal op hoog niveau, zoals CD-spelers
- Optical: om de optie Optical te gebruiken. Controleer of de TV ingesteld is op een digitaal audiosignaal in PCM-formaat

## 8 SUBWOOFER

Duetto biedt de mogelijkheid een externe subwoofer aan het systeem toe te voegen. Om dit te doen: verbind de subwoofer met een RCA-kabel met de ingang van de Duetto masterspeaker die "Sub Out" genoemd wordt. De subwoofer zal automatisch gevonden en aan het systeem toegevoegd worden. Om hem zo goed mogelijk aan de kamer aan te passen, zijn in de webpagina voor de set-up de regelopties gain, cut-off frequency en delay sliders aanwezig. (Hoofdstuk 9)

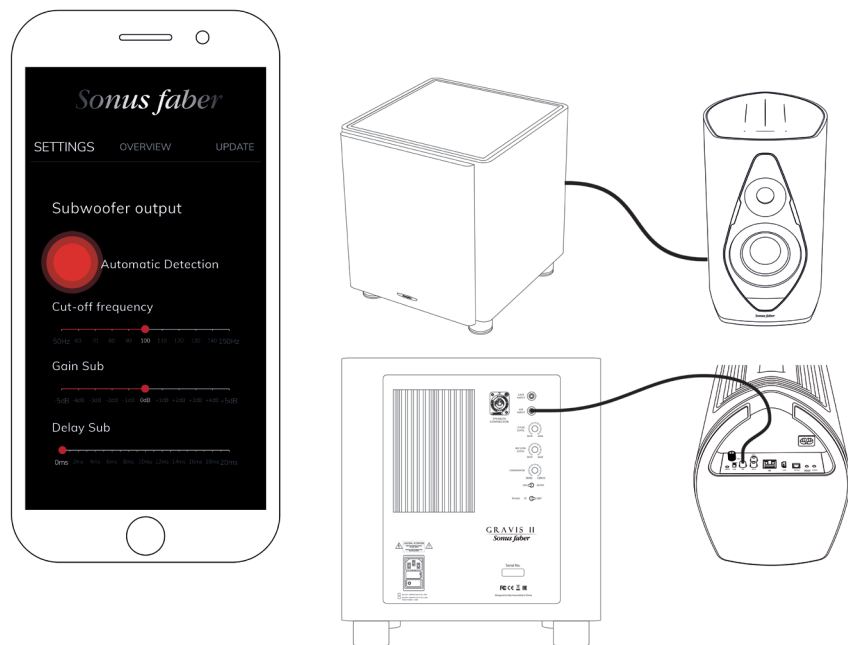

## 9 WEBPAGINA VOOR SET-UP

Ga voor een volledig aangepaste installatie naar de webpagina voor de set-up. Beschikbare aanpassingen: Naam van de Speaker, Power Sleep Timer, Startup Volume Limit, Network Type, Equalization Settings, Room Placement, Master Location, Subwoofer output, HDMI Auto Switching.

- Maak verbinding met het wifi-netwerk (Hoofdstuk 6)
- Scan de QR-code die op de achterkant van de Quick Start Guide staat



De QR-code mag pas gescand worden nadat Duetto met het wifi-netwerk verbonden is. Scan hem niet als het wifi-netwerk niet beschikbaar is. Voer als alternatief in de browser het adres in dat onder de QR-code staat.

## 1 ZAWARTOŚĆ OPAKOWANIA

### 1.1

Zarejestruj Duetto na [sonusfaber.com](https://sonusfaber.com) aby uzyskać dodatkowy 1 rok gwarancji!

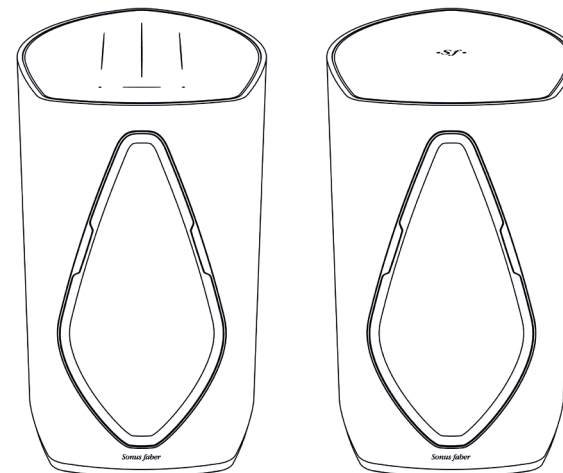

Głośniki ze ściągаныmi maskownicami z tkaniny

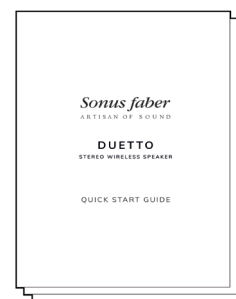

Instrukcja instalacji

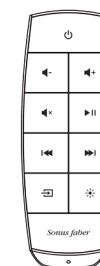

Pilot



Ostony ochronne

PL



Kable zasilające

## 2 KONTROLE

### 2.1 Głośnik

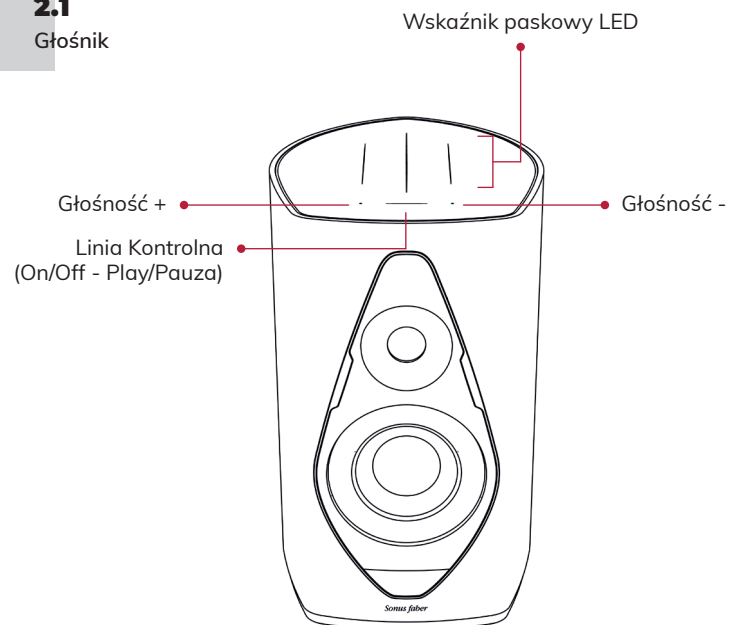

### 2.2 Telecomando

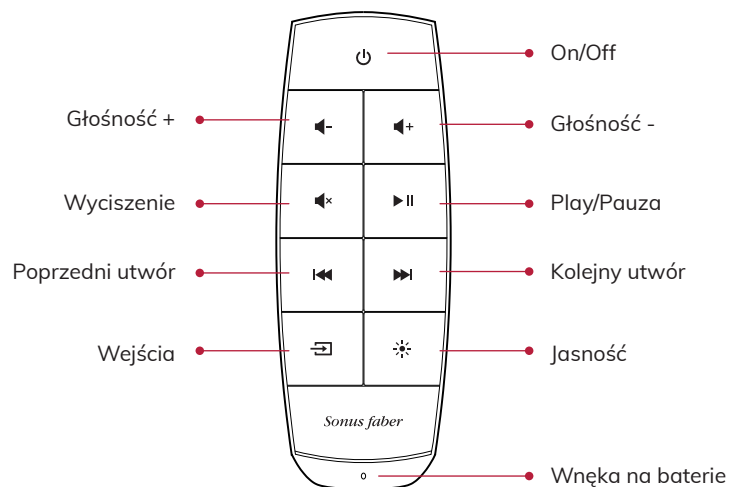

## 3 WEJŚCIA

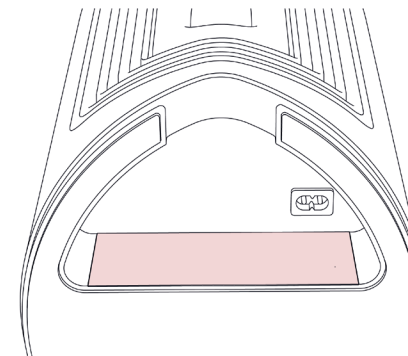

### 3.1 Głośnik główny (Master)

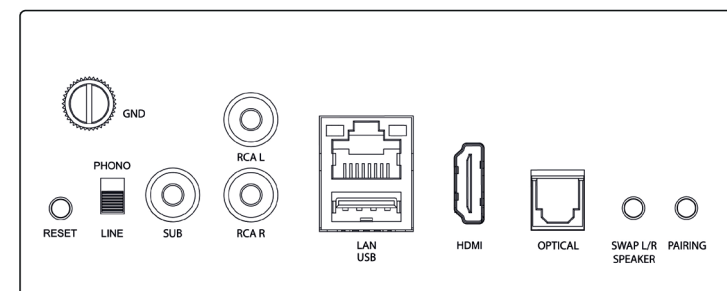

### 3.2 Głośnik drugorzędny (Satellite)

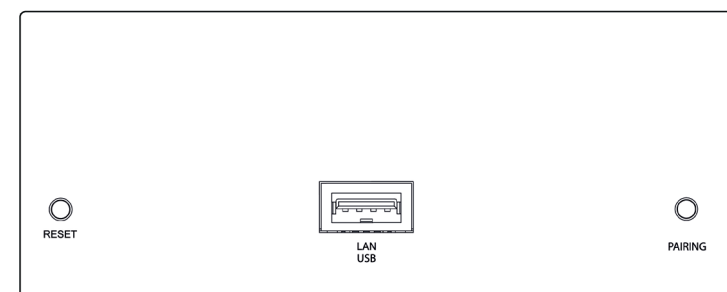

## 4 POCZĄTEK

### 4.1

Umieścić Duetto Master i Satellite (głośnik główny i drugorzędny) w miejscu, w którym mają być używane, następnie podłączyć kabel zasilający.

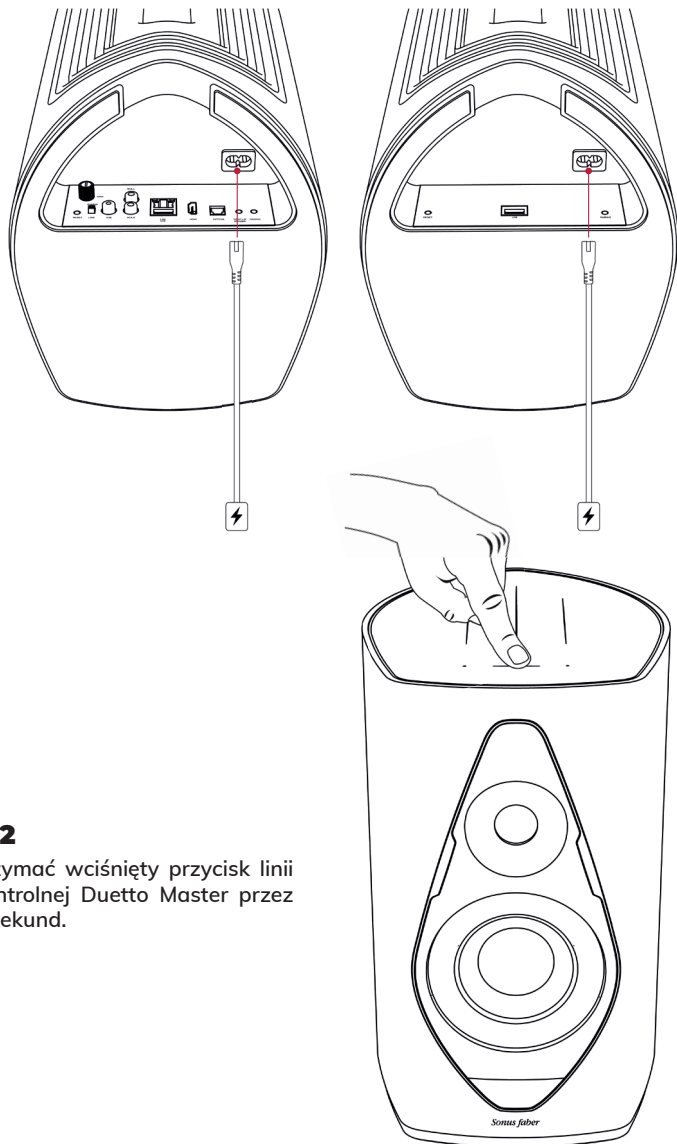

### 4.2

Trzymać wciśnięty przycisk linii kontrolnej Duetto Master przez 5 sekund.

### 4.3

Sparować głośnik Master i Satellite.

Nacisnąć przycisk „Pairing” z tyłu głośnika. W ciągu 30 sekund nacisnąć przycisk „pairing” z tyłu drugiego głośnika.

Głośnik główny (Master)

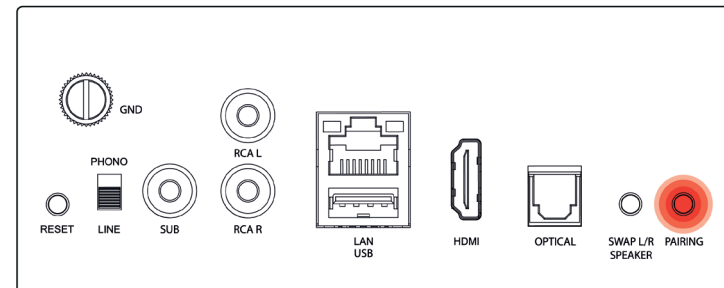

Głośnik drugorzędny (Satellite)

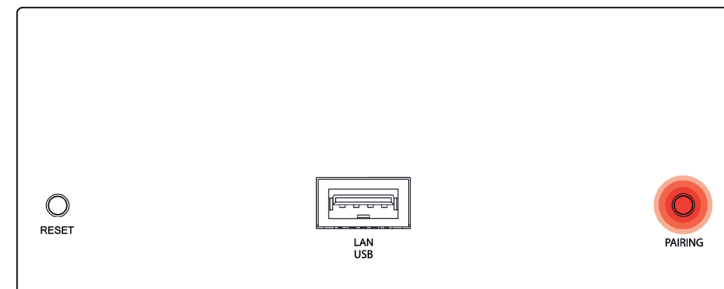

Sygnal świetlny wskaże wykonane sparowanie

## 5 POZYCJONOWANIE

### 5.1

Pozycjonowanie po prawej i po lewej stronie.

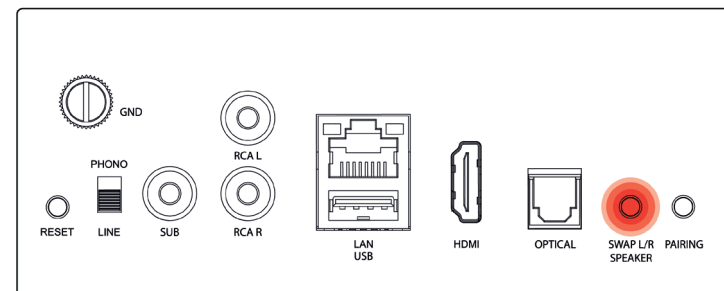



Dla ustawienia fabrycznego, jednostka Master została skonfigurowana jako głośnik lewy. Aby używać go jako głośnik prawy, należy nacisnąć przycisk „SWAP L/R SPEAKER” na karcie wejściowej z tyłu głośnika Master. Sygnał świetlny wskaże wykonane odwrócenie.

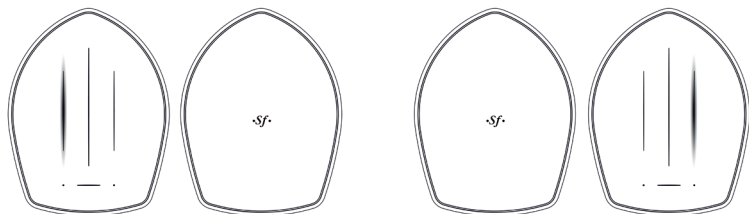

## 5.2

### Pozycjonowanie w pokoju.

Zalecane wymiary pokoju dla optymalnego dźwięku stereo: od 20m<sup>2</sup> do 60m<sup>2</sup>  
Zalecane minimalne odległości dla pozycjonowania głośników: 2m

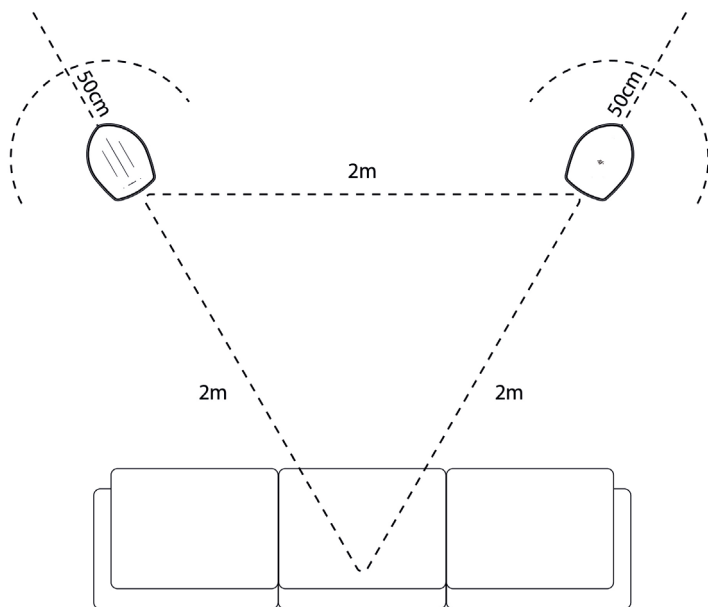

Po podłączeniu Duetto do sieci Wi-Fi, w celu zagwarantowania maksymalnej wszechstronności słuchania w pomieszczeniu, parametry EQ mogą zostać dostosowane na internetowej stronie konfiguracji. (Rozdział 9)

W ustawieniu fabrycznym, głośniki są skonfigurowane tak, by były używane w pewnej odległości od ścian (5cm). Jeśli głośniki są umieszczone w pobliżu ściany, wybrać Room Placement "Near the wall" na internetowej stronie konfiguracji.

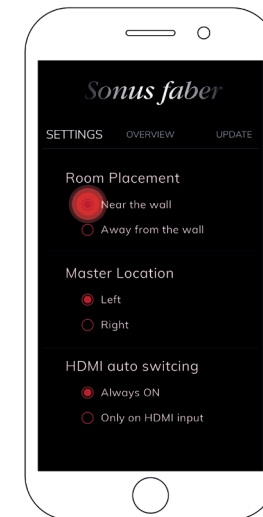

## 6 KONFIGURACJA WI-FI

Podłączyć własne urządzenie do tej samej sieci Wi-Fi, do której podłączony jest Duetto. Kiedy Linia kontrola miga na białym świetłem, głośniki są gotowe do konfiguracji. Duetto obsługuje oba pasma Wi-Fi, 2,4Ghz i 5,2Ghz.

### 6.1

#### Urządzenia iOS

##### Przy użyciu konfiguracji Wi-Fi

- Otworzyć ustawienia na własnym urządzeniu iOS
- Ustawienia Wi-Fi
- Wybrać Duetto-xxxxxx w polu Skonfiguruj nowy głośnik AirPlay
- Wybrać Kolejny, a następnie Gotowe

##### Przy użyciu aplikacji Home

- Zainstalować/zaktualizować aplikację Home
- Otworzyć aplikację Home
- Wybrać Dodaj Akcesorium
- Śledzić wizard w celu skonfigurowania Wi-Fi

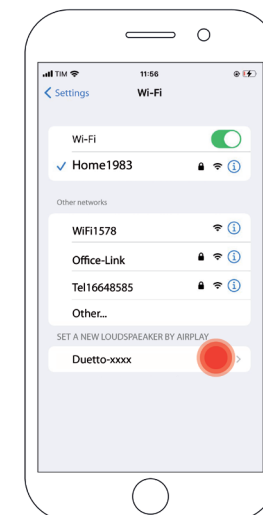

PL

## 6.2

### Urządzenia Android™

- Zainstalować/zaktualizować aplikację Google Home
- Otworzyć aplikację Google Home
- Wybrać + w górze, po prawej stronie
- Wybrać Skonfiguruj nowe urządzenie
- Śledzić wizard w celu skonfigurowania Wi-Fi

## 6.3

### Ethernet

- Podłączyć własny router do Duetto przy pomocy kabla Ethernet

Dalsze informacje i rozwiązanie problemów znajdują się w interaktywnej instrukcji i wideo instalacji na stronie [www.sonusfaber.com/en/products/Duetto/](http://www.sonusfaber.com/en/products/Duetto/)

# 7 ODTWARZANIE MUZYKI

## 7.1

### Aplikacja streaming

Upewnić się, że kolor Linii kontrolnej jest biały. W przeciwnym razie przejść do sekcji 7.2. Włączyć żądaną aplikację i wybrać Duetto z żądanym głośnikiem. Kolorowe światelko Linii kontrolnej zmieni się na podstawie wykorzystywanej usługi streamingowej.

- AirPlay (biały)
- Chromecast built-in (żółty)
- Spotify (zielony)
- Tidal (błękitny/turkusowy)
- Roon (fioletowy)

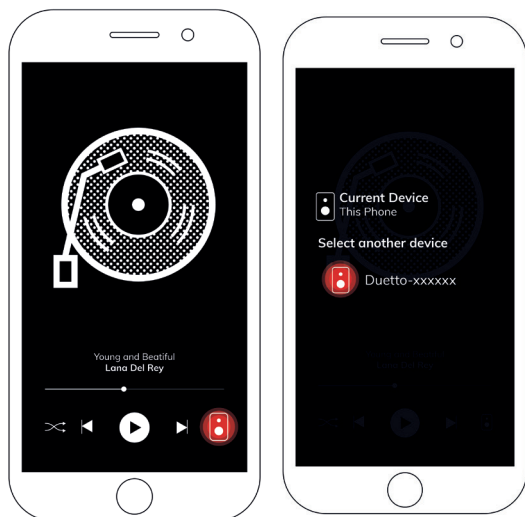

## 7.2

### Wybrać wejście

Zmienić wejście do momentu, gdy Linia kontrolna wskaże kolor żądanego wejścia. Przewinąć od centrum w prawo Linie kontrolną, do momentu, gdy zaświeci ona żądanym kolorem wejścia. Wejście może zostać zmienione również zdalnie, przy użyciu pilota.

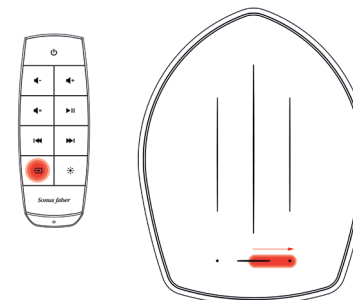

## 7.3

### Bluetooth

- Zmienić wejście, tak by Linia kontrolna zaświeciła się na niebiesko
- W ustawieniach Bluetooth własnego urządzenia wybrać wyszukiwanie nowego urządzenia
- Wybrać Duetto-xxxxxx z listy dostępnych urządzeń Bluetooth
- Kiedy niebieskie światło Linii kontrolnej przestanie migać Duetto będzie gotowy do odtwarzania muzyki

## 7.4

### Wejścia fizyczne

Zmienić wejście do momentu, gdy Linia kontrolna wskaże kolor żądanego wejścia:

- HDMI (pomarańczowy)
- Optical (fukcja)
- Line/Phono (magenta)

Upewnić się, że urządzenie analogowe zostało skonfigurowane prawidłowo. Wymaga urządzeń::

- HDMI ARC: wybrać konfigurację sygnału TV PCM/Stereo
- Phono stage: Głowice (MM) phono z wyjściem od 2,4mV do 5,0mV. Upewnić się, że na karcie wejściowej został wybrany Phono na karcie wejściowej z tyłu Duetto. Line In jest dedykowana sygnałowi wysokiego poziomu, takiemu jak odtwarzacz CD
- Optical: użyć opcji Optical. Upewnić się, że TV została skonfigurowana na sygnał audio digital w formacie PCM

## 8 SUBWOOFER

Duetto ma możliwość dodania do systemu zewnętrznego subwoofer. Aby tego dokonać, podłączyć kabel RCA przez subwoofer do wejścia Duetto Master o nazwie „Sub Out”. Subwoofer zostanie zlokalizowany automatycznie i dodany do systemu. Aby jak najlepiej dostosować go do pomieszczenia, na internetowej stronie konfiguracji obecne są opcje regulacji gain, cut-off frequency i delay sliders. (Rozdział 9)

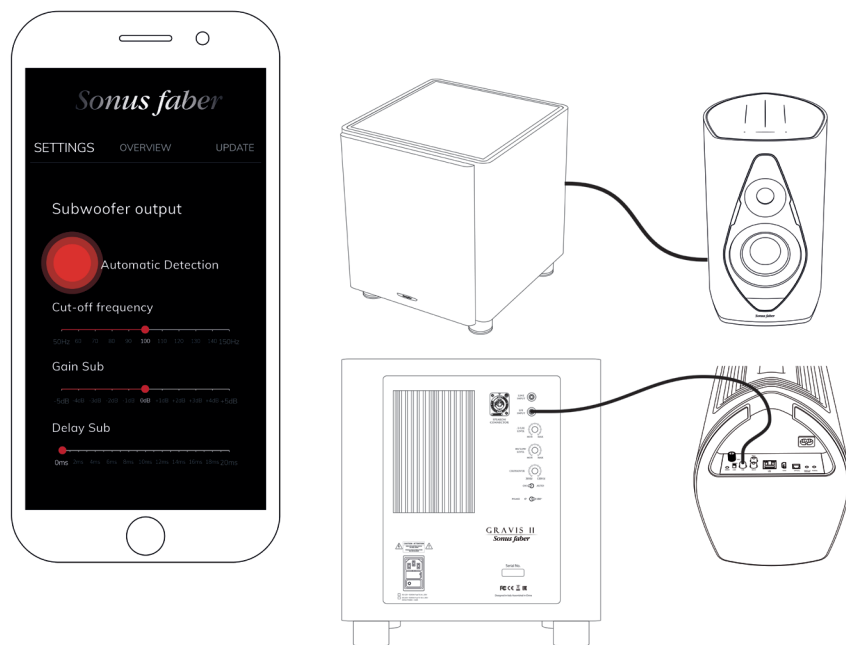

## 9 INTERNETOWA STRONA KONFIGURACJI

Dla indywidualnie dostosowanej instalacji, wejdź na internetową stronę konfiguracji. Dostępne dostosowania: Nazwa głośnika, Power Sleep Timer, Startup Volume Limit, Network Type, Equalization Settings, Room Placement, Master Location, Subwoofer output, HDMI Auto Switching,

- Podłączyć się o sieci Wi-Fi (Rozdział 6)
- Zeskanować kod QR umieszczony na tylnej stronie Quick Start Guide



Kod QR musi zostać zeskanowany po podłączeniu Duetto do sieci Wi-Fi. Nie skanować go, jeśli nie ma dostępnej sieci Wi-Fi. W alternatywie, wprowadzić w pasek przeglądarki adres znajdujący się pod kodem QR.

## 1 包裝內含物品

### 1.1

在sonusfaber.com網站上註冊Duetto，可增加1年保修期！

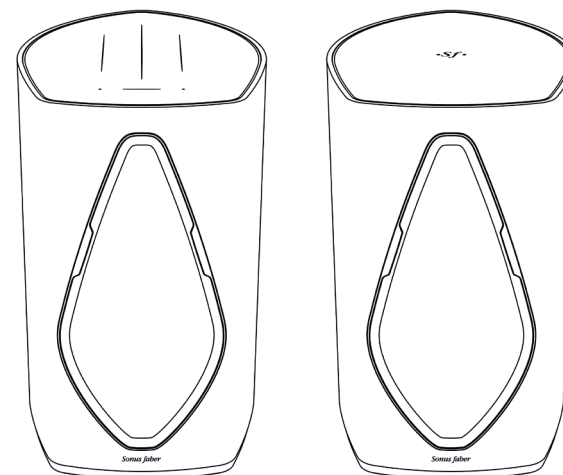

音響配有可移除的布罩

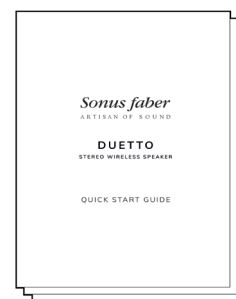

安裝指南

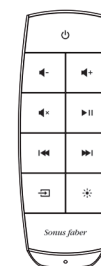

遙控器



防護蓋板

繁體中文



電源線

## 2 控制

### 2.1 音箱

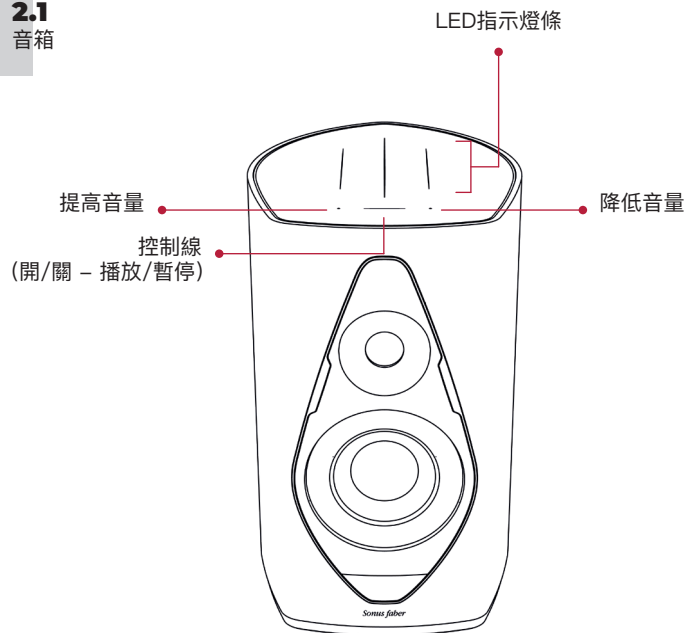

### 2.2 遙控器

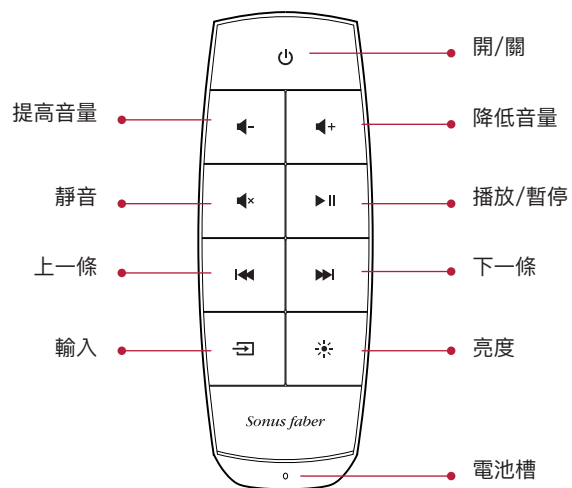

## 3 輸入端

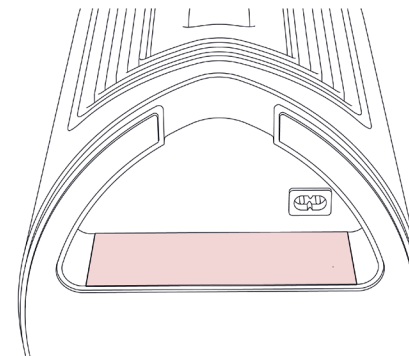

### 3.1 主音箱

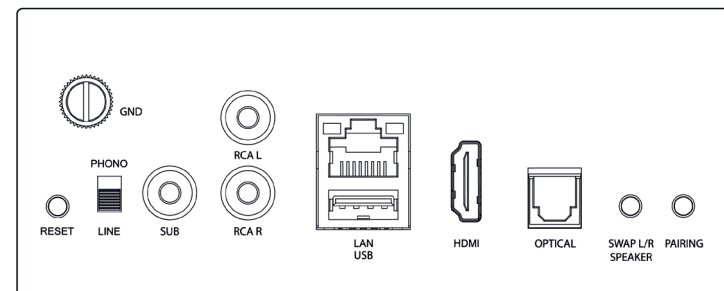

### 3.2 副音箱

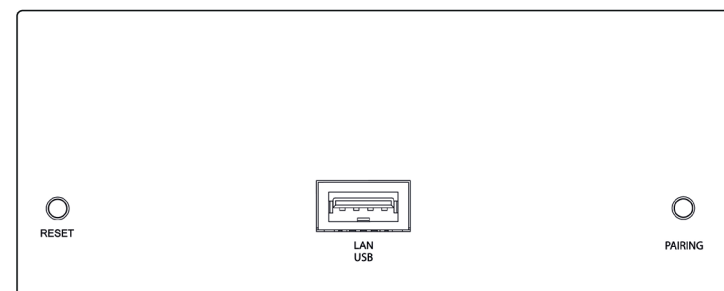

# 4 開始

## 4.1

將Duetto主音箱和副音箱安置在需要使用處，隨後連接電源線

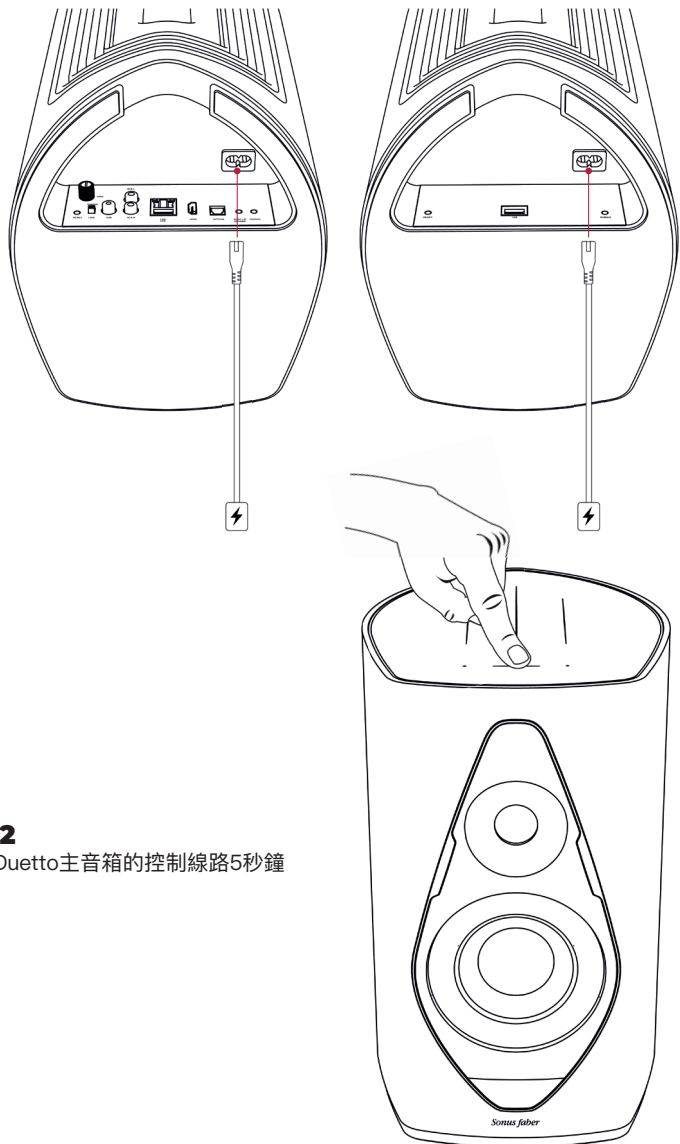

## 4.2

按Duetto主音箱的控制線路5秒鐘

## 4.3

### 主副音箱配對

按下一個音箱背面的“配對”鍵。在30秒內按下另一個音箱背面的“配對”鍵

主音箱

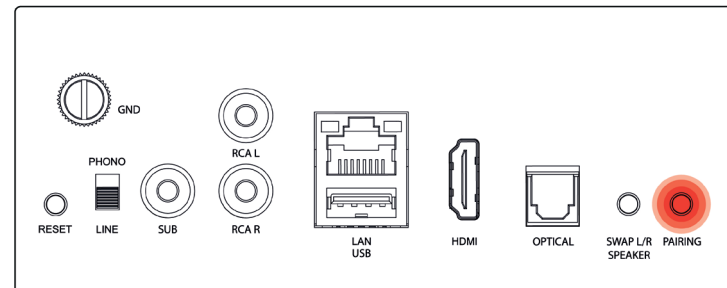

副音箱

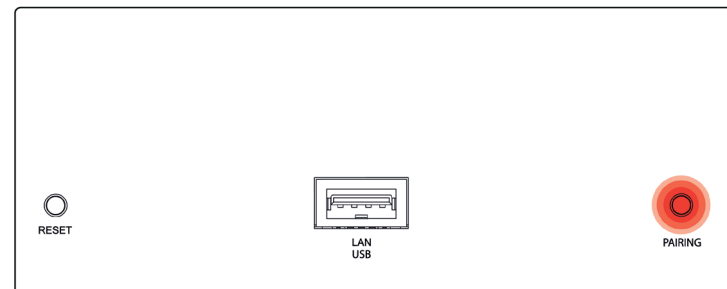

亮光表示配對完成

# 5 定位

## 5.1

### 左右側定位

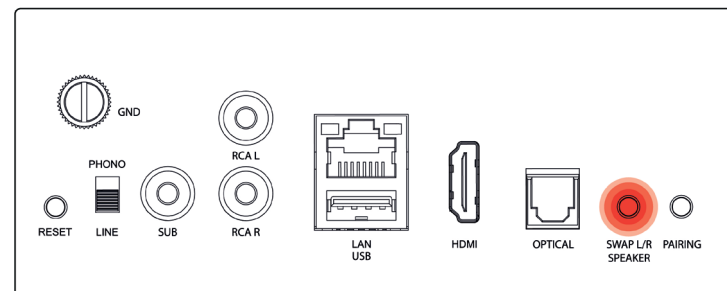

在預定義設置中，主音箱默認為左音箱。如要將其作為右音箱使用，需按下Duetto主音箱背面輸入卡上方的“左/右音箱交換”鍵。亮光表示定位反轉。

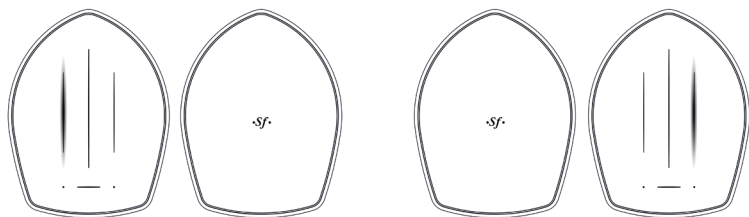

## 5.2 房間內定位

收聽最佳立體聲的推薦房間大小：20m<sup>2</sup>至60m<sup>2</sup>  
 音箱定位的推薦最小距離：2m

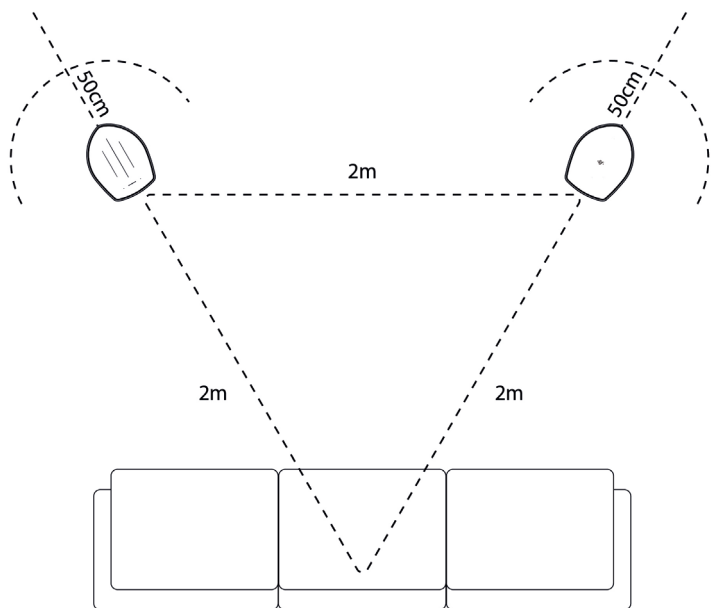

Duetto連接了Wi-Fi網絡後，為保證房間內最大的音響多樣化，可以通過配置網頁來適配EQ參數。（第9章）

在默認配置中，已設置使用音箱時距離壁面（50cm）。如果音箱安置在壁面附近，在配置網頁內選擇房間擺放為“靠近牆面”。

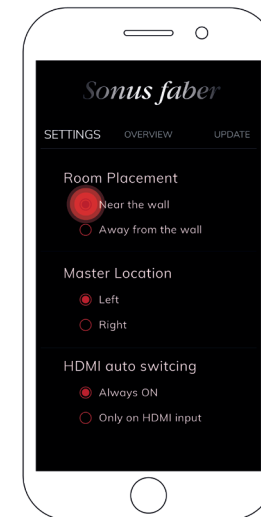

## 6 WI-FI配置

讓您的設備和Duetto共享一個Wi-Fi網絡。  
 當控制線路閃爍為白色時，音箱就準備好進行配置。  
 Duetto可支持2.4Ghz和5.2Ghz的Wi-Fi頻段

### 6.1 iOS設備

#### 通過Wi-Fi配置

- 在您的IOS設備上打開“設置”
- 設置Wi-Fi
- 在“配置新AirPlay音箱”內選擇Duetto-xxxxxx
- 選擇“下一步”，然後“完成”

#### 打開“家庭”應用程序

- 安裝/更新應用程序“家庭”
- 打開“家庭”應用程序
- 選擇“添加配件”
- 按照嚮導設置Wi-Fi連接

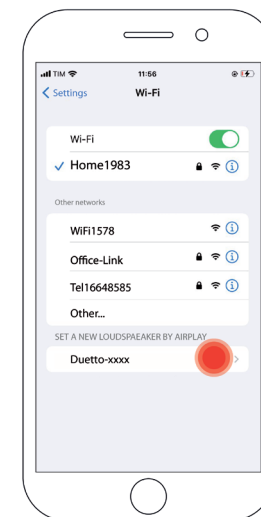

繁體中文

## 6.2

### Android™設備

- 安裝/更新應用程序Google Home
- 打開應用程序Google Home
- 點擊左上方的“+”
- 選擇配置新設備
- 按照嚮導設置Wi-Fi連接

## 6.3

### 以太網

- 通過以太網線將您的路由器連接到Duetto

有關更多詳細信息和故障排除，請到網站參閱交互式手冊和安裝視頻，網址為  
[www.sonusfaber.com/en/products/Duetto/](http://www.sonusfaber.com/en/products/Duetto/)

# 7 播放音樂

## 7.1

### 流媒體應用程序

確保控制線路為白色。反之則前往章節7.2  
訪問所需的應用程序，並選擇含所需音箱的Duetto  
現在，控制線路的燈光顏色將根據所用的流媒體服務而變化

- AirPlay (白色)
- 內置Chromecast (黃色)
- Spotify (綠色)
- Tidal (藍色/土耳其藍)
- Roon (紫色)

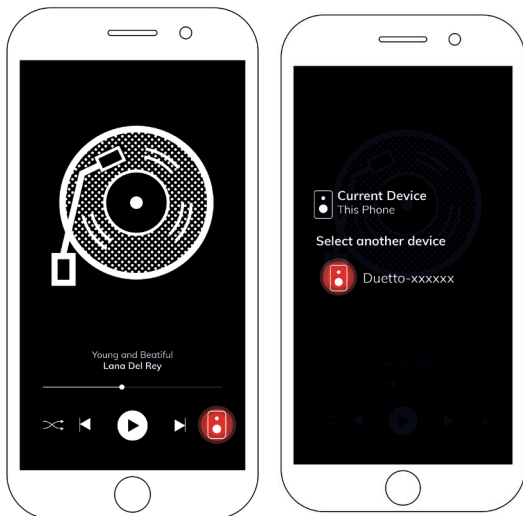

## 7.2

### 選擇輸入

更改輸入，直至控制線路顯示所需的輸入顏色  
從控制線路的中央向右滑動，直至其變為所需的輸入顏色  
還可以遙控更改輸入。

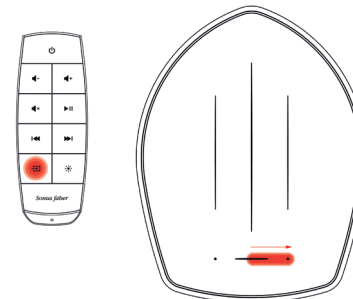

## 7.3

### 藍牙

- 更改輸入，直至控制線路開始閃爍藍光
- 在您設備的藍牙設置內，選擇搜索新設備
- 在可用的藍牙設備列表中選擇Duetto-xxxxxx
- 當控制線路停止閃爍藍色時，Duetto就準備好播放音樂了

## 7.4

### 物理輸入

更改輸入，直至控制線路顯示所需的輸入顏色

- HDMI (橙色)
- 光纖 (玫紅色)
- 線路/Phono (洋紅色)

確保模擬設備已正確配置  
設備需要：

- HDMI ARC: 選擇TV PCM/立體聲信號配置
- Phono stage: 2.4mV至5.0mV輸出的唱頭 (MM)。確保在Duetto背後的輸入卡內選擇Phono。輸入線專用於CD播放器等高級信號
- 光纖：使用“光纖”選項。確保電視機配置為PCM格式的數字音頻信號

## 8 低音炮

Duetto允許給系統外接一個低音炮。連接時，需將低音炮的不平衡RCA電纜連接到Duetto主音箱的“Sub Out”輸入端。低音炮將被自動識別並添加到系統。為了更好地適應房間，配置網頁內有增益調整、截止頻率和延遲滑塊選項。（第9章）

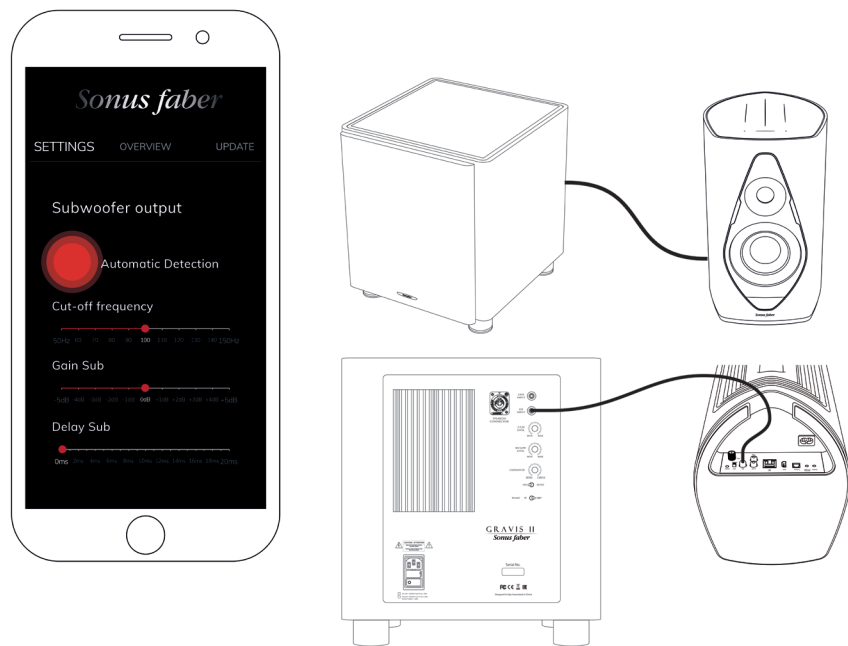

## 9 配置網頁

如要進行完全自定義安裝，可訪問配置網頁。  
可自定義的功能：音箱名、電源睡眠定時器、啟動音量限制、網絡類型、均衡設置、房間安置、主音箱位置、低音炮輸出、HDMI自動開關

- 連接到Wi-Fi網絡（第6章）
- 掃描《快速啟動指南》背面的二維碼



只有在把Duetto連接了Wi-Fi網絡後，才能掃描二維碼  
如果Wi-Fi網絡不可用，則不要掃描  
或者可以在瀏覽器中輸入二維碼下方的地址

## 1 包装内含物品

### 1.1

在sonusfaber.com网站上注册Duetto，可增加1年保修期！

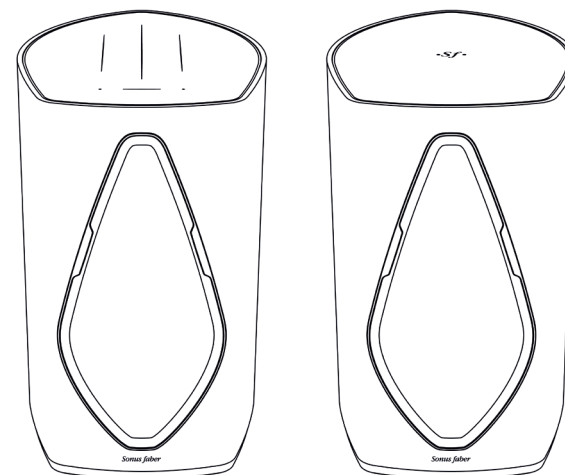

音响配有可移除的布罩

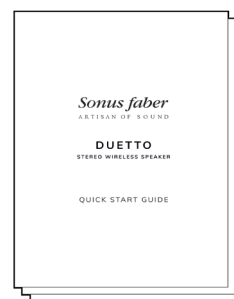

安装指南

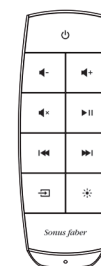

遥控器



防护盖板



电源线



## 2 控制

### 2.1 音箱

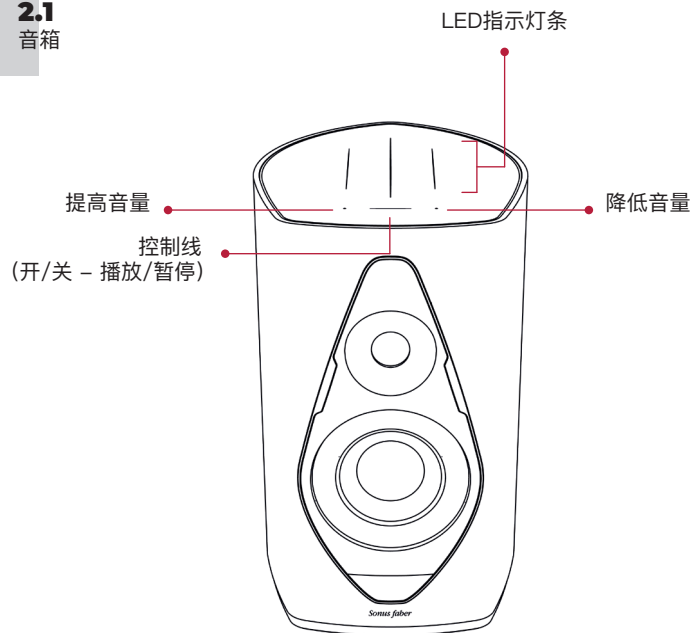

### 2.2 遥控器

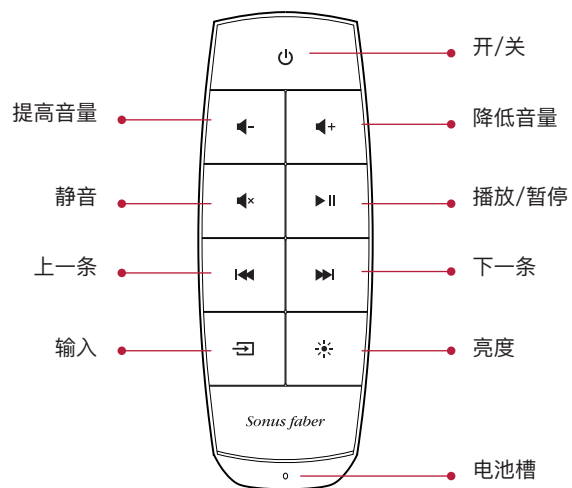

## 3 输入端

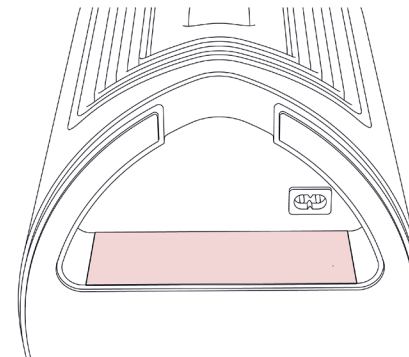

### 3.1 主音箱

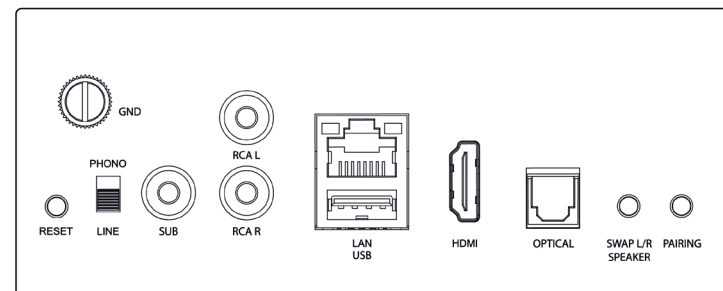

### 3.2 副音箱

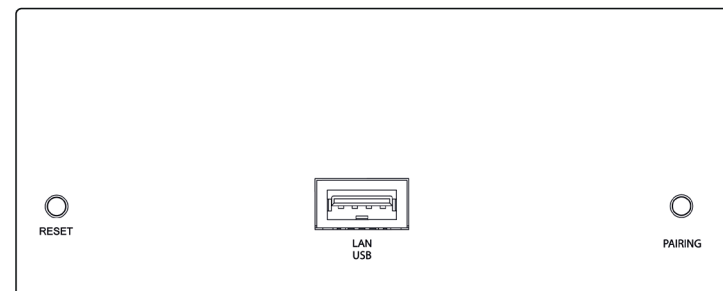

## 4 开始

### 4.1

将Duetto主音箱和副音箱安置在需要使用处，随后连接电源线

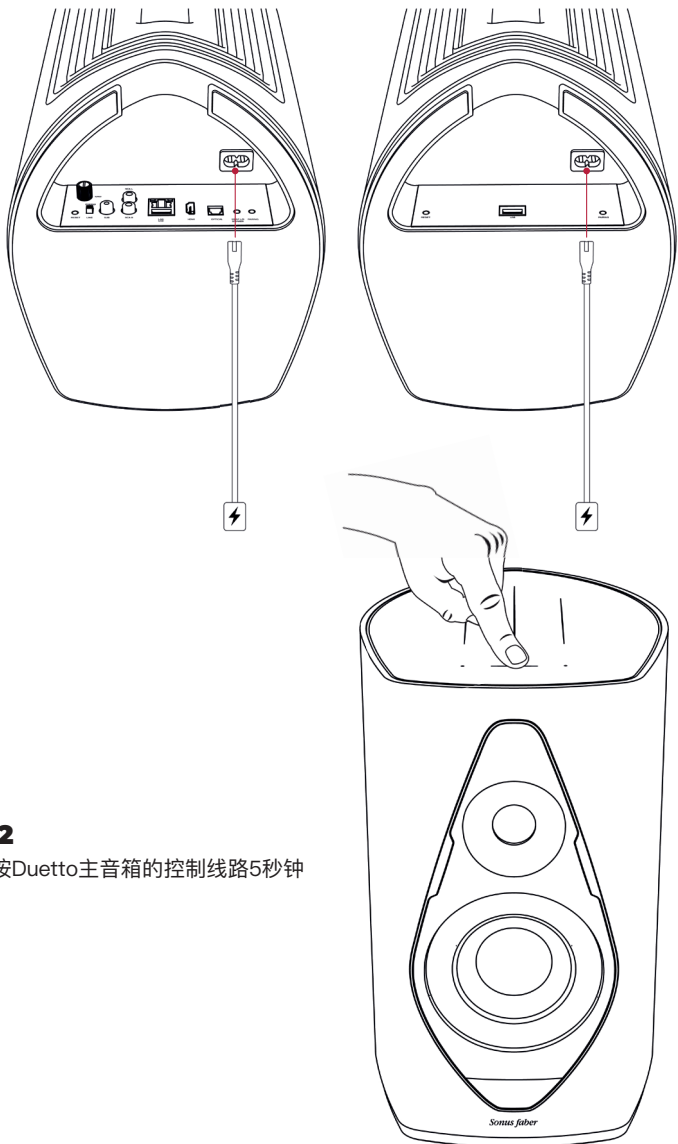

### 4.2

长按Duetto主音箱的控制线路5秒钟

### 4.3

主副音箱配对

按下一个音箱背面的“配对”键。在30秒内按下另一个音箱背面的“配对”键

主音箱

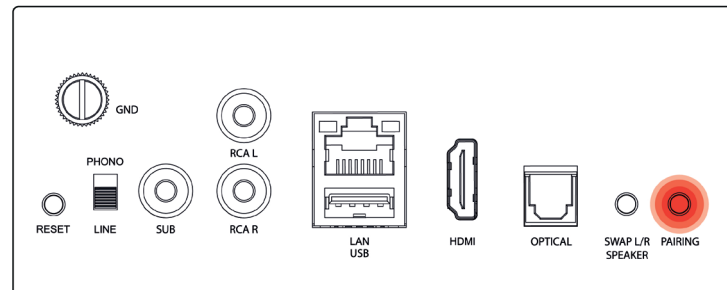

副音箱

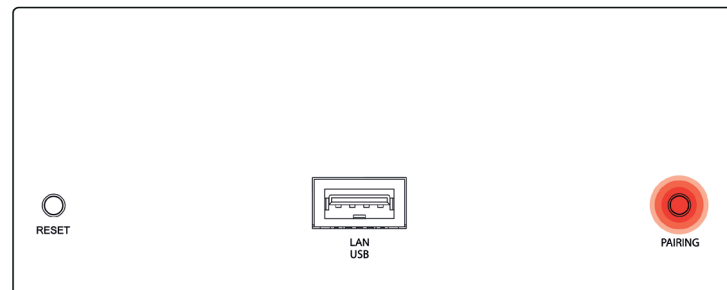

亮光表示配对完成

## 5 定位

### 5.1

左右侧定位

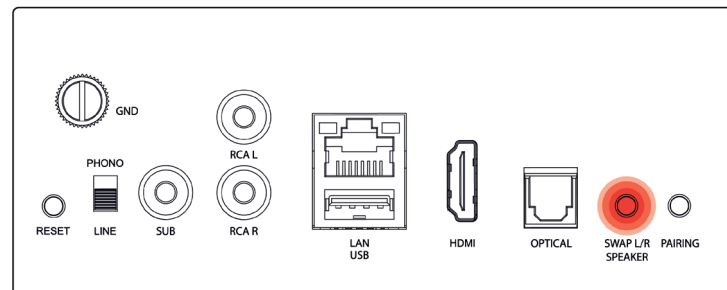

在预定义设置中，主音箱默认为左音箱。如要将其作为右音箱使用，需按下Duetto主音箱背面输入卡上方的“左/右音箱交换”键。亮光表示定位反转。

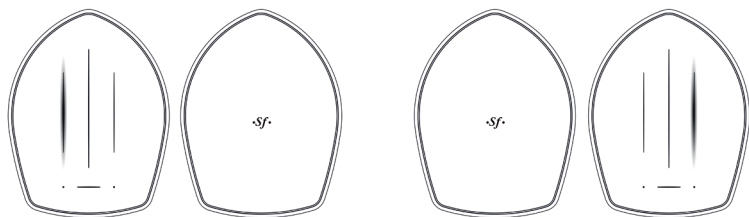

## 5.2

### 房间内定位

收听最佳立体声的推荐房间大小：20m<sup>2</sup>至60m<sup>2</sup>  
音箱定位的推荐最小距离：2m

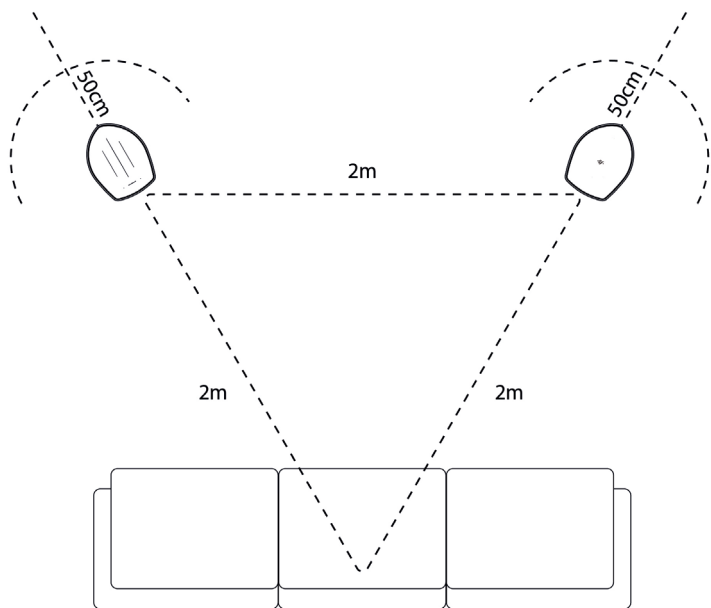

Duetto连接了Wi-Fi网络后，为保证房间内最大的音响多样化，可以通过配置网页来适配EQ参数。（第9章）

在默认配置中，已设置使用音箱时距离壁面（50cm）。如果音箱安置在壁面附近，在配置网页内选择房间摆放为“靠近墙面”。

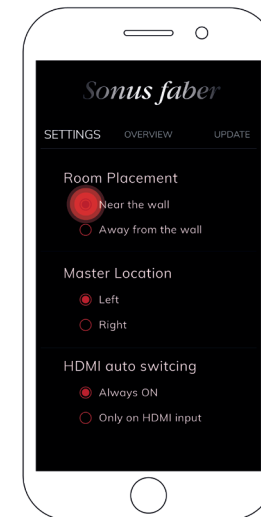

## 6 WI-FI配置

让您的设备和Duetto共享一个Wi-Fi网络。  
当控制线路闪烁为白色时，音箱就准备好进行配置。  
Duetto可支持2.4Ghz和5.2Ghz的Wi-Fi频段

### 6.1

#### iOS设备

##### 通过Wi-Fi配置

- 在您的iOS设备上打开“设置”
- 设置Wi-Fi
- 在“配置新AirPlay音箱”内选择Duetto-xxxxxx
- 选择“下一步”，然后“完成”

##### 打开“家庭”应用程序

- 安装/更新应用程序“家庭”
- 打开“家庭”应用程序
- 选择“添加配件”
- 按照向导设置Wi-Fi连接

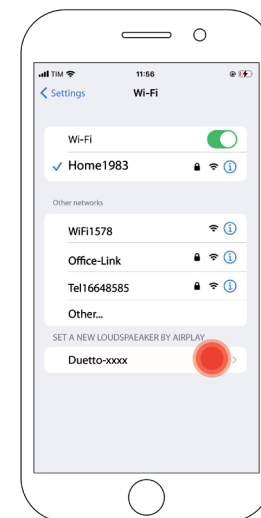

中文

## 6.2

### Android™设备

- 安装/更新应用程序Google Home
- 打开应用程序Google Home
- 点击左上方的“+”
- 选择配置新设备
- 按照向导设置Wi-Fi连接

## 6.3

### 以太网

- 通过以太网线将您的路由器连接到Duetto

有关更多详细信息和故障排除，请到网站参阅交互式手册和安装视频，网址为  
[www.sonusfaber.com/en/products/Duetto/](http://www.sonusfaber.com/en/products/Duetto/)

# 7 播放音乐

## 7.1

### 流媒体应用程序

确保控制线路为白色。反之则前往章节7.2  
 访问所需的应用程序，并选择含所需音箱的Duetto  
 现在，控制线路的灯光颜色将根据所用的流媒体服务而变化

- AirPlay (白色)
- 内置Chromecast (黄色)
- Spotify (绿色)
- Tidal (蓝色/土耳其蓝)
- Roon (紫色)

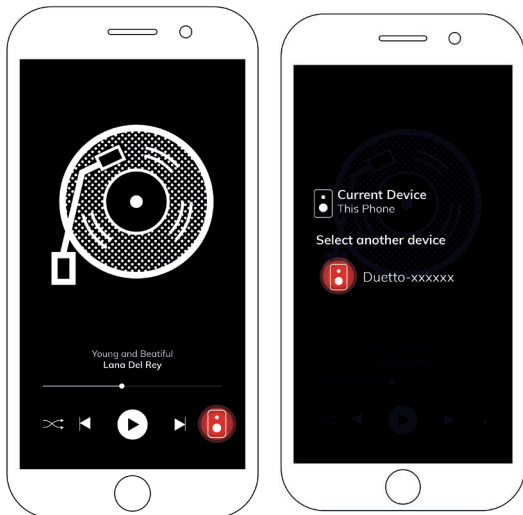

## 7.2

### 选择输入

更改输入，直至控制线路显示所需的输入颜色  
 从控制线路的中央向右滑动，直至其变为所需的输入颜色  
 还可以遥控更改输入。

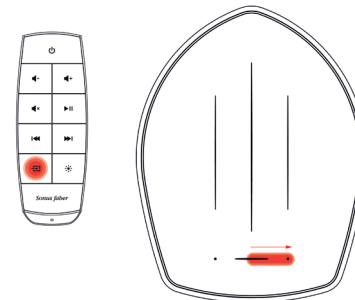

## 7.3

### 蓝牙

- 更改输入，直至控制线路开始闪烁蓝光
- 在您设备的蓝牙设置内，选择搜索新设备
- 在可用的蓝牙设备列表中选择Duetto-xxxxxx
- 当控制线路停止闪烁蓝色时，Duetto就准备好播放音乐了

## 7.4

### 物理输入

更改输入，直至控制线路显示所需的输入颜色

- HDMI (橙色)
- 光纤 (玫红色)
- 线路/Phono (洋红色)

确保模拟设备已正确配置  
 设备需要：

- HDMI ARC: 选择TV PCM/立体声信号配置
- Phono stage: 2.4mV至5.0mV输出的唱头 (MM)。确保在Duetto背后的输入卡内选择Phono。输入线专用于CD播放器等高级信号
- 光纤: 使用“光纤”选项。确保电视机配置为PCM格式的数字音频信号

## 8 低音炮

Duetto允许给系统外接一个低音炮。连接时，需将低音炮的不平衡RCA电缆连接到Duetto主音箱的“Sub Out”输入端。低音炮将被自动识别并添加到系统。为了更好地适应房间，配置网页内有增益调整、截止频率和延迟滑块选项。（第9章）

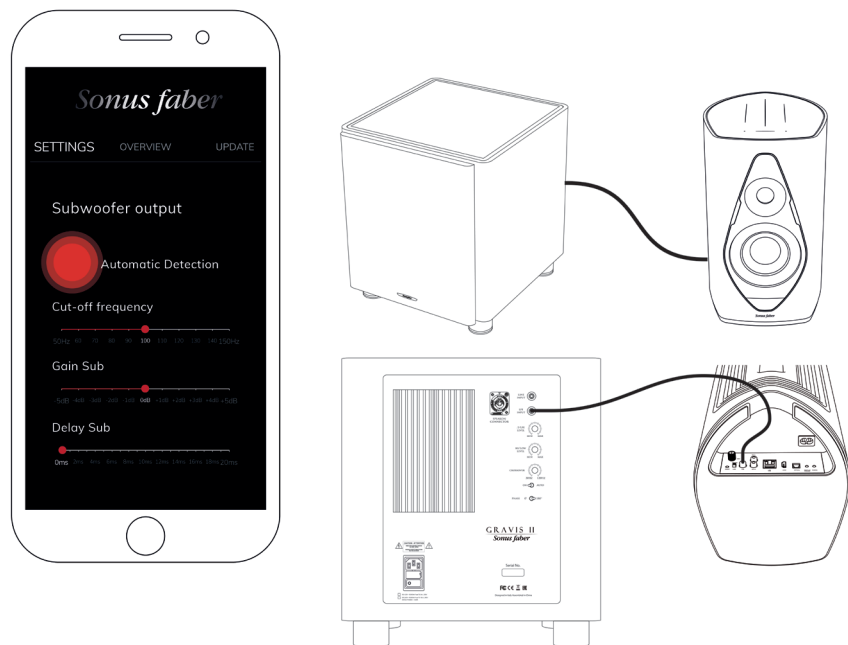

## 9 配置网页

如要进行完全自定义安装，可访问配置网页。  
可自定义的功能：音箱名、电源睡眠定时器、启动音量限制、网络类型、均衡设置、房间安置、主音箱位置、低音炮输出、HDMI自动开关

- 连接到Wi-Fi网络（第6章）
- 扫描《快速启动指南》背面的二维码



只有在把Duetto连接了Wi-Fi网络后，才能扫描二维码  
如果Wi-Fi网络不可用，则不要扫描  
或者可以在浏览器中输入二维码下方的地址

## 1 패키지 내용물

### 1.1

Duetto를 sonusfaber.com에서 등록하면 1년 보증이 추가로 적용됩니다!

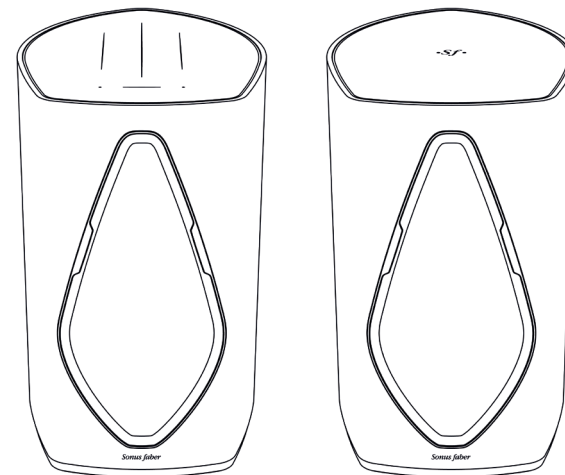

탈착식 패브릭 커버가 있는 스피커

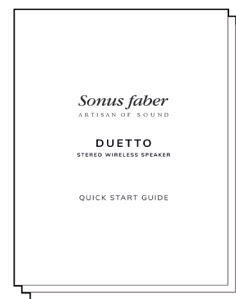

설치 안내서

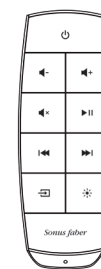

리모컨



보호 덮개



전원 케이블

## 2 점검

### 2.1 스피커

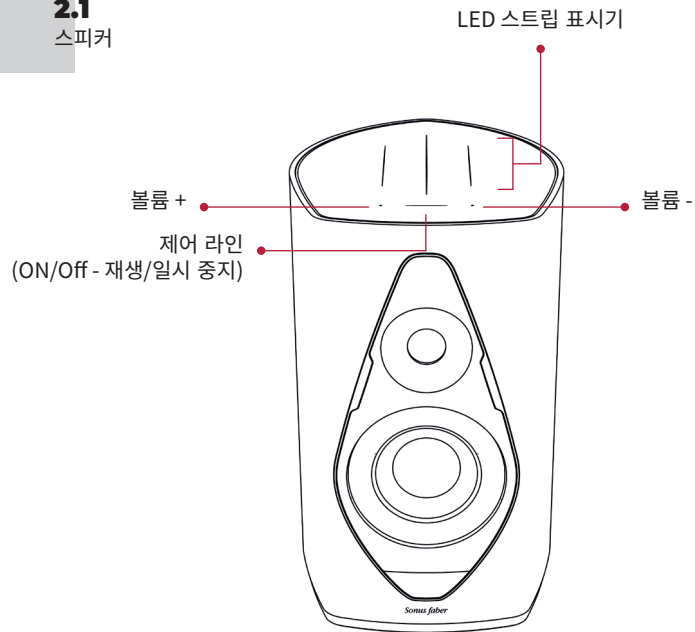

### 2.2 리모컨

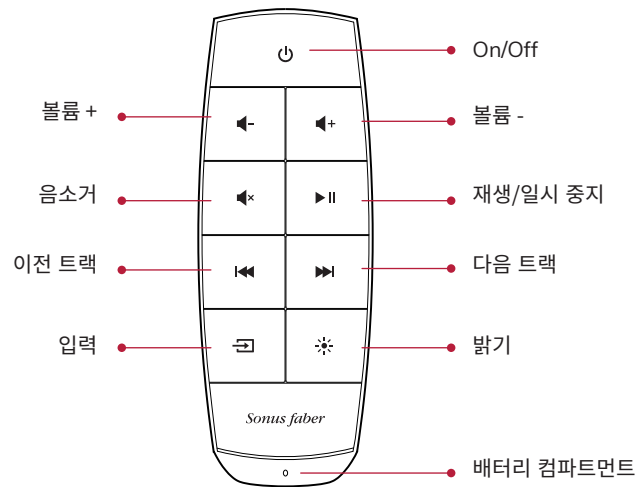

## 3 입력

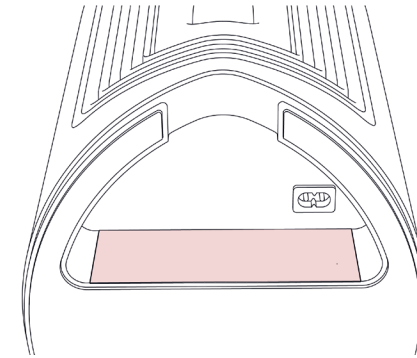

### 3.1 마스터 스피커

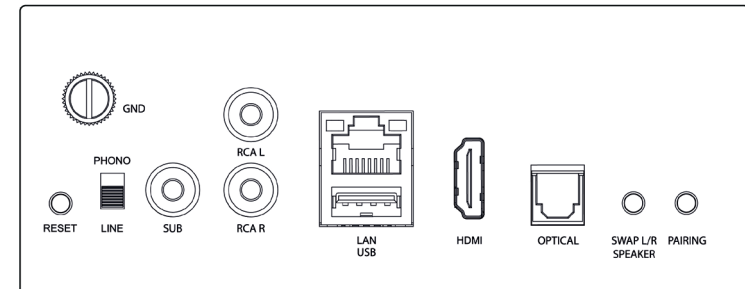

### 3.2 새틀라이트 스피커

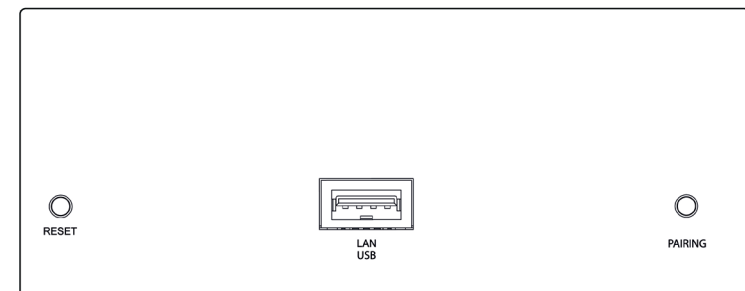

# 4 시작

## 4.1

Duetto 마스터와 새틀라이트를 사용하려는 위치에 배치한 후, 전원 케이블을 연결합니다

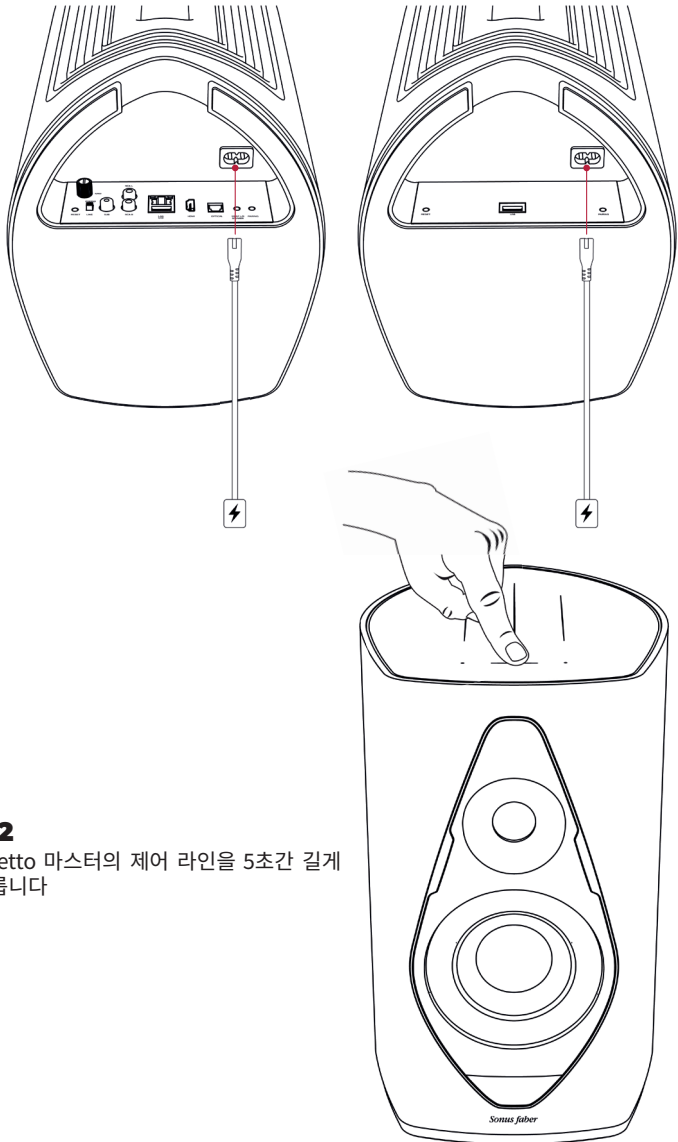

## 4.2

Duetto 마스터의 제어 라인을 5초간 길게 누릅니다

## 4.3

마스터와 새틀라이트를 페어링합니다.

스피커 한 개의 뒷면에 있는 '페어링' 버튼을 누릅니다. 30초 안에 다른 스피커 뒤에 있는 '페어링' 버튼을 누릅니다

마스터 스피커

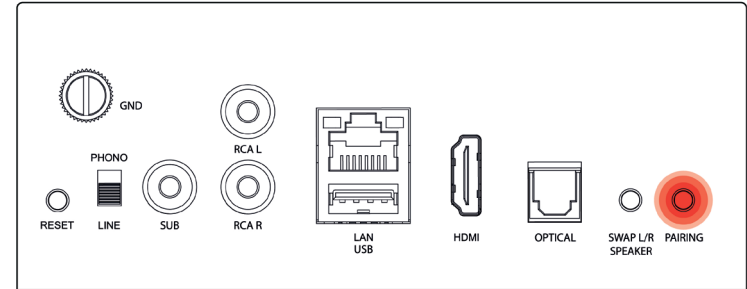

새틀라이트 스피커

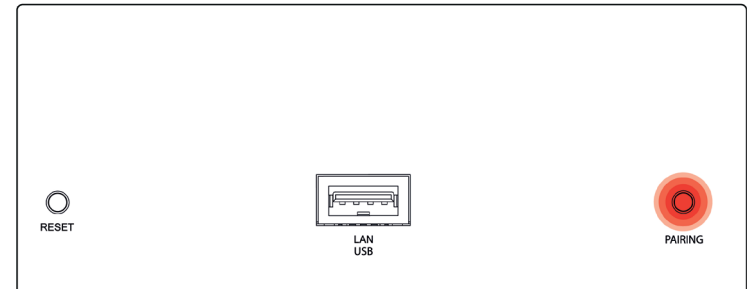

페어링이 성공했음을 나타내는 불빛이 움직입니다

# 5 배치

## 5.1

좌우 위치 결정

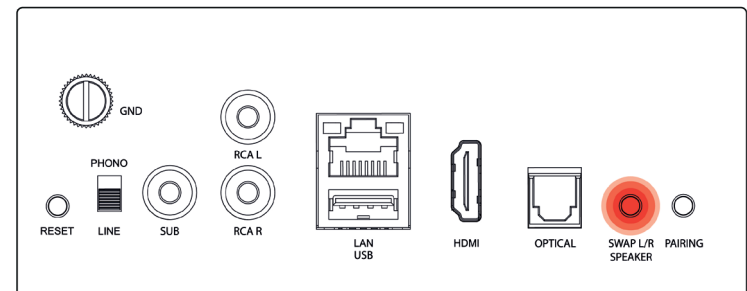

기본적으로 마스터 유닛은 왼쪽 스피커로 설정됩니다. 오른쪽 스피커로 사용하려면 Duetto 마스터 뒷면의 입력 보드에 있는 'SWAP L/R SPEKER' 버튼을 누르십시오. 불빛이 움직이면서 위치가 바뀌었음을 알립니다.



## 5.2

### 실내 배치

최적의 스테레오 청취를 위해 권장하는 실내 크기: 20m<sup>2</sup> ~ 60m<sup>2</sup>  
스피커 배치를 위한 최소 권장 거리: 2m

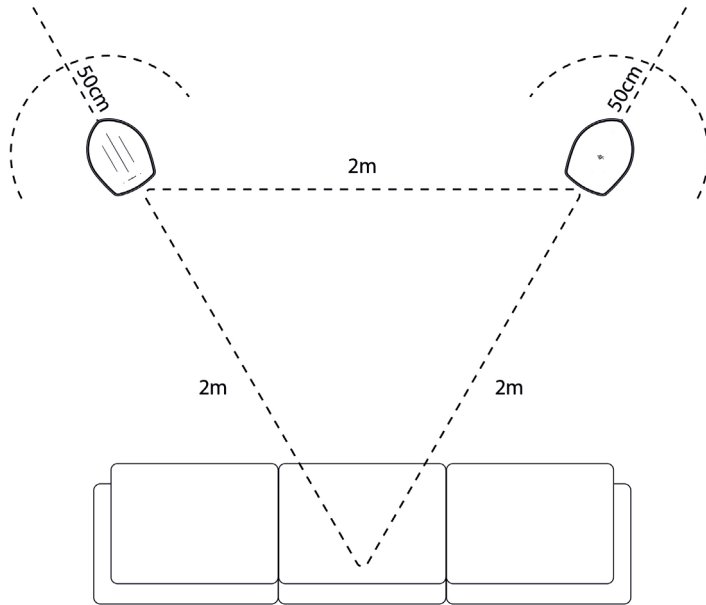

Duetto를 Wi-Fi 네트워크에 연결한 후, 실내에서 최대의 청취 다기능성을 보장하기 위해, 웹 설정 페이지를 통해 EQ 매개변수를 조정할 수 있습니다. (9장)

기본적으로 스피커는 벽에서 (50cm) 떨어져 사용하도록 설정되었습니다. 스피커가 벽에 가까이 배치된 경우, 웹 설정 페이지에서 'Near the wall' 실내 배치를 선택합니다.

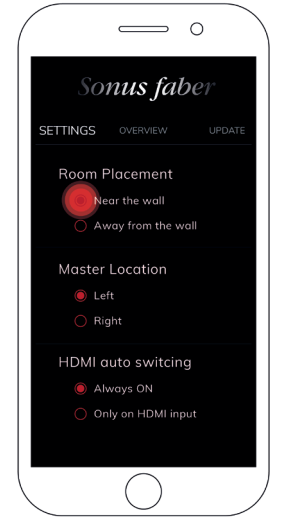

# 6 WIFI 설정

Duetto가 연결된 Wi-Fi 네트워크에 장치를 연결합니다. 제어 라인이 흰색으로 깜박이면 스피커를 설정할 준비가 됩니다. Duetto는 2.4Ghz 및 5.2Ghz Wi-Fi 대역을 모두 지원합니다

## 6.1

### iOS 기기

#### Wi-Fi 설정 사용

- iOS 장치에서 설정을 엽니다
- Wi-Fi 설정
- 새 AirPlay 스피커 설정에서 Duet-xxxxxxx를 선택합니다
- '다음'을 선택한 후 '완료'를 선택합니다

#### Home 앱 사용

- Home 앱 설치/업데이트
- Home 앱을 엽니다
- 액세서리 추가하기를 선택합니다
- 마법사의 지시에 따라 Wi-Fi를 설정합니다

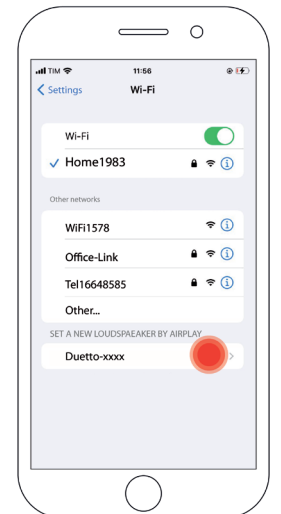



## 6.2

### Android™ 장치

Google Home 앱을 설치/업데이트 합니다  
 Google Home 앱을 엽니다  
 왼쪽 상단의 + 기호를 선택합니다  
 새 장치 설정을 선택합니다  
 마법사의 지시에 따라 Wi-Fi를 설정합니다

## 6.3

### 이더넷

이더넷 케이블을 통해 라우터를 Duetto에 연결합니다

자세한 내용과 문제 해결에 대한 정보는 웹사이트([www.sonusfaber.com/en/products/Duetto/](http://www.sonusfaber.com/en/products/Duetto/))를 방문하여 대화형 설명서 및 설치 비디오를 참조하십시오

# 7 음악 재생

## 7.1

### 스트리밍 앱

제어 라인의 색상이 흰색인지 확인합니다. 그렇지 않은 경우 섹션 7.2로 이동합니다  
 원하는 앱에 액세스하고 원하는 스피커가 포함된 Duetto를 선택합니다  
 이제 사용 중인 스트리밍 서비스에 따라 제어 라인의 색상 표시등이 변경됩니다

- AirPlay (화이트)
- 내장된 Chromecast (옐로우)
- Spotify (그린)
- Tidal (스카이블루/터콰이즈)
- Roon (바이올렛)

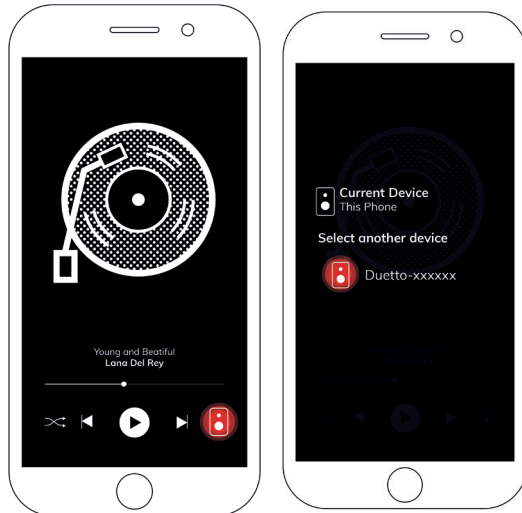

## 7.2

### 입력 선택

제어 라인에 원하는 입력 색상이 나타날 때까지 입력을 바꿉니다  
 원하는 입력의 색상이 나타날 때까지 제어 라인의 중앙에서 오른쪽으로 스크롤합니다  
 리모컨을 사용하여 원격으로 입력을 변경할 수도 있습니다.

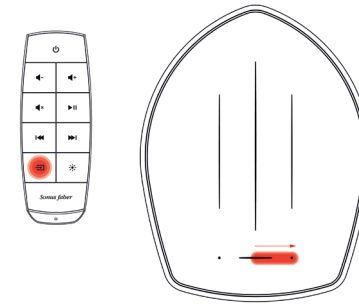

## 7.3

### 블루투스

- 제어 라인이 파란색으로 깜박이기 시작할 수 있습니다
- 장치의 블루투스 설정에서 새 장치 검색을 선택합니다
- 사용 가능한 블루투스 장치 목록에서 Duetto-xxxxxx를 선택합니다
- 파란색 제어 라인 표시등이 깜박이지 않으면 Duetto가 음악을 재생할 준비가 됩니다

## 7.4

### 물리적 입력

제어 라인에 원하는 입력 색상이 나타날 때까지 입력을 바꿉니다

- HDMI (오렌지)
- 옵티컬 (푸크시아)
- 라인/포노 (마젠타)

아날로그 장치가 올바르게 구성되었는지 확인하십시오  
 필요한 장치:

- HDMI ARC: PCM/Stereo TV 신호 설정 선택
- 포노 프리앰프: 2.4mV~5.0mV 출력의 포노(MM) 카트리지. Duetto 뒷면의 입력 보드에서 포노를 선택하십시오. 라인 입력은 CD 플레이어와 같은 하이 레벨 신호 전용입니다
- 옵티컬: 옵티컬 옵션을 사용합니다. TV가 PCM 형식의 디지털 오디오 신호로 설정되어 있는지 확인하십시오

## 8 서브우퍼

Duetto를 사용하면 시스템에 외부 서브우퍼를 추가할 수 있습니다. 추가하려면, 서브우퍼의 RCA 케이블을 'Sub Out'이라는 라벨이 붙은 Duetto 마스터 입력에 연결합니다. 서브우퍼가 자동으로 감지되어 시스템에 추가됩니다. 설치된 실내에 맞춰 조정할 수 있도록, 게인, 차단 주파수 및 지연 슬라이더 조정 옵션이 설정 웹 페이지에 있습니다. (9장)

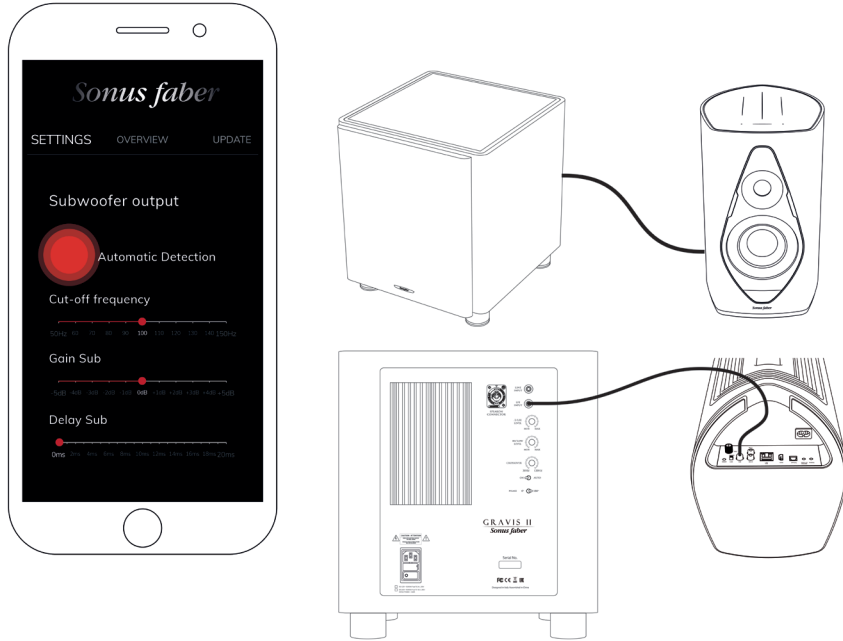

## 9 설정 웹 페이지

전체 사용자 정의가 가능한 설치를 위해 웹 설정 페이지에 액세스합니다. 이용 가능한 사용자 지정 사항: 스피커 이름, 전원 절전 타이머, 시작 볼륨 제한, 네트워크 유형, 이퀄라이제이션 설정, 실내 배치, 마스터 위치, 서브우퍼 출력, HDMI 자동 전환

- Wi-Fi 네트워크에 연결합니다 (6장)
- 빠른 시작 안내서 뒷면에 있는 QR 코드를 스캔합니다



Wi-Fi 네트워크에 Duetto를 연결한 후에만 QR 코드를 스캔해야 합니다  
Wi-Fi 네트워크를 사용할 수 없는 경우 스캔하지 마십시오  
또는, QR 코드 아래에 있는 주소를 브라우저에 입력합니다

**NOTA BENE:** Conserva l'imballo originale di Duetto per eventuali futuri trasporti.  
Per la pulizia di Duetto, usa un panno morbido eventualmente Appena inumidito dopo averlo scollegato.

**PLEASE NOTE:** Keep the original Duetto packaging for future transport.  
Clean Duetto after disconnection using a slightly damp soft cloth.

**N.B.** Conservez l'emballage d'origine d'Duetto pour tout transport futur.  
Pour nettoyer Duetto, utilisez un chiffon doux éventuellement légèrement humidifié après avoir déconnecté l'Appareil.

**BITTE BEACHTEN:** Bewahren Sie die Originalverpackung des Duetto für eventuelle zukünftige Transporte auf. Um Ihren Duetto zu reinigen, verwenden Sie ein weiches, leicht feuchtes Tuch, nachdem Sie ihn vom Stromnetz getrennt haben.

**NOTA:** Se recomienda guardar el embalaje original de Duetto para futuros transportes.  
Para limpiar Duetto, desconectarlo y utilizar un paño suave y apenas humedecido.

**OBSERVAÇÃO:** Guarde a embalagem original Duetto para eventuais transportes futuros.  
Para a limpeza de Duetto, use um pano macio eventualmente humedecido, depois de desconectá-lo.

**LET OP:** Bewaar de originele verpakking voor eventueel later transport.  
Reinig Duetto met een zachte en eventueel licht bevochtigde doek na het Apparaat te hebben afgekoppeld.

**ZANOTUJ:** Zachowaj oryginalne opakowanie Duetto dla ewentualnych przyszłych transportów.  
Dla czyszczenia Duetto, po odłączeniu, użyj Duetto szmatki, ewentualnie lekko zwilżonej.

**注意**  
請妥善保存Duetto的原包裝，以便將來需要運輸時使用。  
清潔Duetto時，需先斷開電源，然後用一塊柔軟抹布擦拭，必要時可以沾少量的水。

**注意**  
請妥善保存Duetto的原包裝，以便將來需要運輸時使用。  
清潔Duetto時，需先斷開電源，然後用一塊柔軟抹布擦拭，必要時可以沾少量的水。

**주의:**  
나중에 이동할 때를 위해 Duetto의 원래 포장을 잘 보관하십시오.  
청소할 때는, Duetto의 전원 연결을 해제한 후 약간 촉촉한 부드러운 천을 사용하십시오.

# TRADEMARK AND LICENCE

The Sonus faber Duetto incorporates copyright protected technology that is protected by Italian patents and other Intellectual property rights. The Sonus faber Duetto uses the following Technologies:



Use of the Works with Apple badge means that an accessory has been designed to work specifically with the technology identified in the badge and has been certified by the developer to meet Apple performance standards. Apple, iPad, iPad Air, iPad Pro, iPhone and AirPlay are trademarks of Apple Inc., registered in the U.S. and other countries. To control this AirPlay 2-enabled speaker, iOS 11.4 or later is required.

## Chromecast built-in™

Google, Android, Google Home and Chromecast built-in are trademarks of Google LLC.



Being Roon Ready means that Sonus faber uses Roon streaming technology, for an incredible user interface, simple setup, rock-solid daily reliability, and the highest levels of audio performance, without compromise.



Use your phone, tablet or computer as a remote control for Spotify.

Go to [spotify.com/connect](https://spotify.com/connect) to learn how.

The Spotify Software is subject to third party licenses found here: [www.spotify.com/connect/third-party-licenses](https://www.spotify.com/connect/third-party-licenses)



High Fidelity Music Streaming



The Bluetooth® word mark and logos are registered trademarks owned by Bluetooth SIG, Inc. and any use of such marks by Sonus faber, is under license. Other trademarks and trade names are those of their respective owners.



CERTIFIED

The Wi-Fi CERTIFIED logo is a registered trademark of the Wi-Fi Alliance. Wi-Fi CERTIFIED Logo indicates the product has undergone rigorous testing by Wi-Fi Alliance and has demonstrated interoperability with other products, including those from other companies that bear the Wi-Fi CERTIFIED Logo.



Qualcomm aptX is a product of Qualcomm Technologies, Inc. and/or its subsidiaries. Qualcomm is a trademark of Qualcomm Incorporated, registered in the United States and other countries. aptX is a trademark of Qualcomm Technologies International, Ltd., registered in the United States and other countries.



The terms HDMI®, HDMI High-Definition Multimedia Interface, and the HDMI Logo are trademarks or registered trademarks of HDMI Licensing Administrator, Inc.

# NOTE

---

---

---

---

---

---

---

---

---

---

---

---

---

---

---

---

---

---

---

---

---

---

---

---

---



QR code to the direct link to the Web  
Base Setup page after Wi-Fi connected

